

A4 PRINTING INSTRUCTIONS

Before you get started on creating your Rossi of Fredy Wrap, make sure to read the below notes so that you can make sure your printer is calibrated and prints the patterns to the correct size.

Before you begin, please make sure you are printing on A4 paper with an A4 printer, not letter paper as the small difference in the paper size can mean your patterns don't print correct. A4 measures 210 x 297mm

1. Select Layers / styles:

Make sure you have gone through the PDF and selected all necessary layers + Customisations that you need for your Rossi / Fredy Wrap in instructions. You can print out all the customisations if you wish to make more variations in future.

2. Print the first three pages as a test print:

We strongly suggest printing the first three pages as a test to make sure everything is set up correctly, to save time, paper and the environment.

When printing in Adobe Acrobat, do as follows:

- File > Print
- Select your printer
- Click 'Pages' and then type '1 - 3' (for test print)
- Click 'Custom Scale' and type '100%'
- Click 'PRINT'

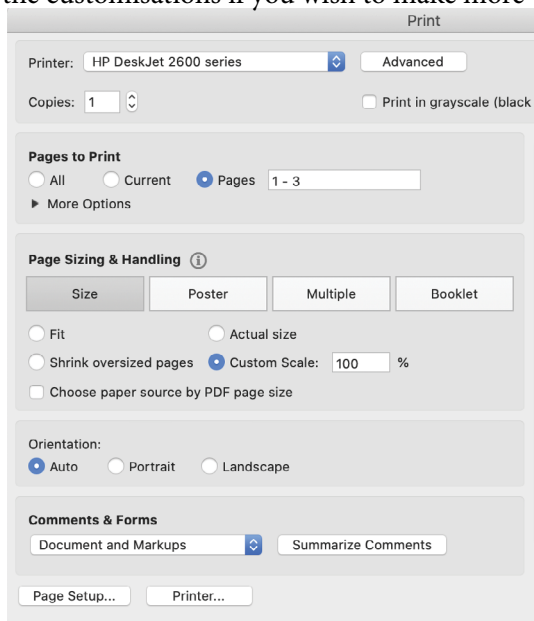

3. Calibrate and measure

When printing, although you would've selected '100%', most common household printers will print with a white border. Don't worry, this won't affect measurements and you **SHOULD NOT** trim the borders. However, to check this is correct for your printer – we have provided two tests of calibration squares.

3a: Single Square Calibration

On the first pattern page, you will see a 5x5cm square and a 1"x1" square. Using your ruler, measure these squares to make sure they (along with your patterns) have printed to the correct scale.

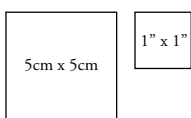

Note: These calibration squares are an example only and are not printed to scale.

3b: Across-Page Diamond Calibration

You will then see a grey diamond split across the first two pattern pages (similar to the below example). Simply measure from one corner of the diamond to the other corner. This should measure 5cm from left point to right point.

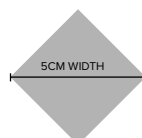

Note: This diamond is an example only and is not printed to scale.

4. You're all set and ready to go!

Once you have successfully tested and printed the first couple of pages, and double-checked the calibration as per steps 3a and 3b, you're all set to go!

5cm x 5cm

1" x 1"

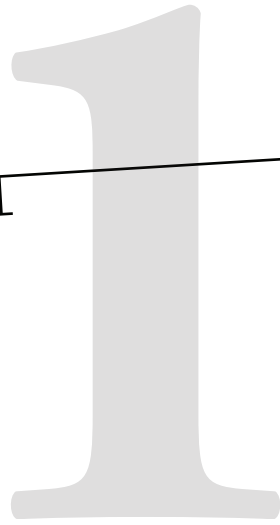

ROSSI & FREDY

SIZE 8

SIDE FRONT #1

Details:

Connect Pattern Piece to #2
at notches at top of pattern piece.

Once connected:

Cut x 1 Pair (2 pieces all up)

Seam Allowance included: 1cm (3/8")

5CM WIDTH

ROSSI & FREDY

SIZE 8

SIDE FRONT #2

Details:
Connect Pattern Piece to
front #1 at notches below.

Once connected:
Refer to **SIDE FRONT #1**
for cutting instructions:
Seam Allowance included:
1cm (3/8")

Grain Line

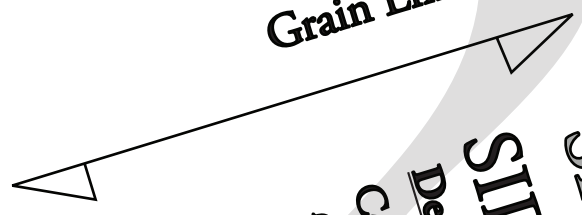



ROSSI & FREDY

SIZE 8

CENTRE
FRONT MAIN #2

Details:

Connect Pattern Piece to
CFront #1 at notches below.

Once connected:
Refer to CENTRE FRONT #1
for cutting instructions
Seam Allowance included: 1cm (3/8")

t h e b o l d o n e

Fredy Wrap + Rossi Wrap – Size 8

© The Bold One Workshop Patterns.
These patterns are copyrighted by
The Bold One Patterns and may not
be copied, shared, or resold.

Reproducing this pattern to sell items
commercially is prohibited.

Seam allowance = 1cm (3/8")

Use the following boxes to check
pattern has been printed to correct scale.

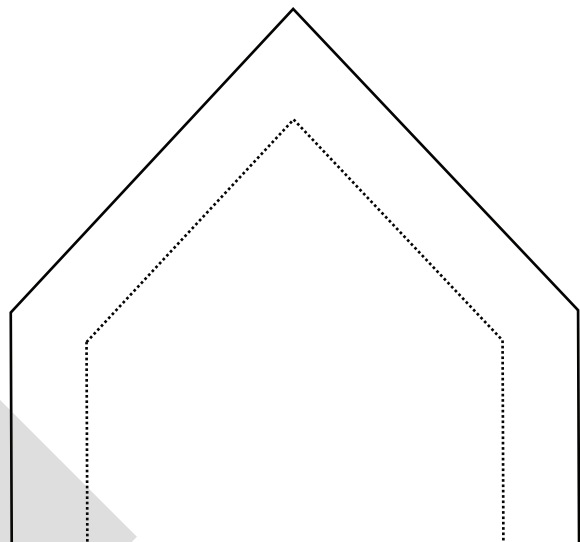
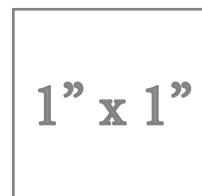
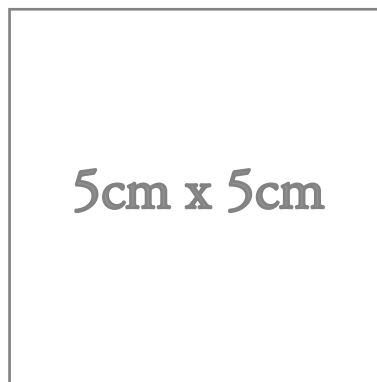



5



← **Optional Leg
Split notch**

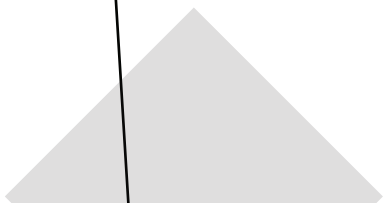

6

T

Grain line

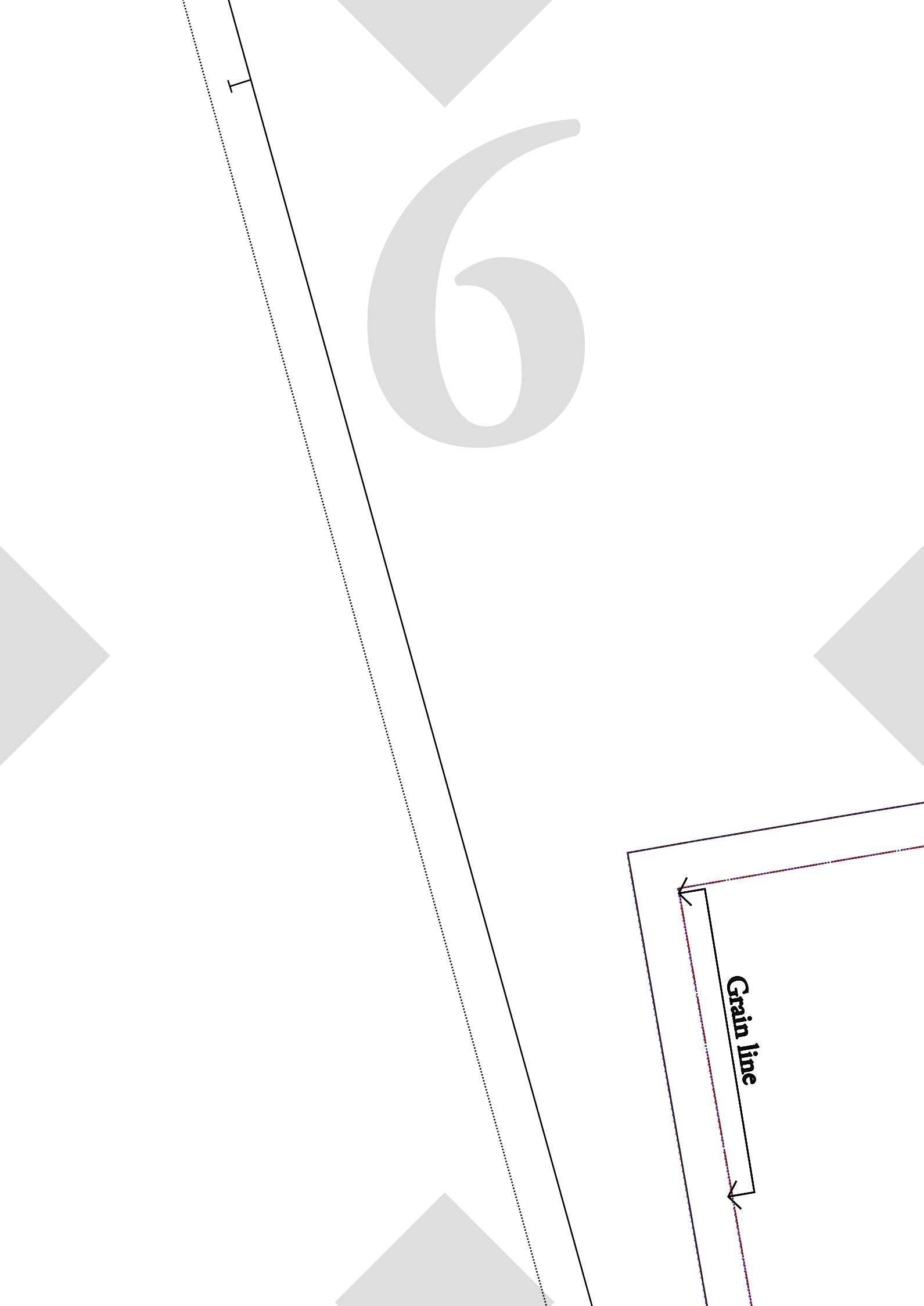

NECKLINE LINE KEY:

Boat Neck Front:

V Front:

Standard Square Front:

Fold Line / Grain line

Details:
Cut x1 Pair (x2 pieces in total)
Seam Allowance included:
1cm (3/8")

Deep Square Front:

Standard Square Front:

V Front:

Boat Neck Front:

NECKLINE LINE KEY:

ROSSI WRAP

DEEP SQUARE NECK SHOULDER TIE

Cut x4

Seam Allowance included: 1cm (3/8")

Grain Line

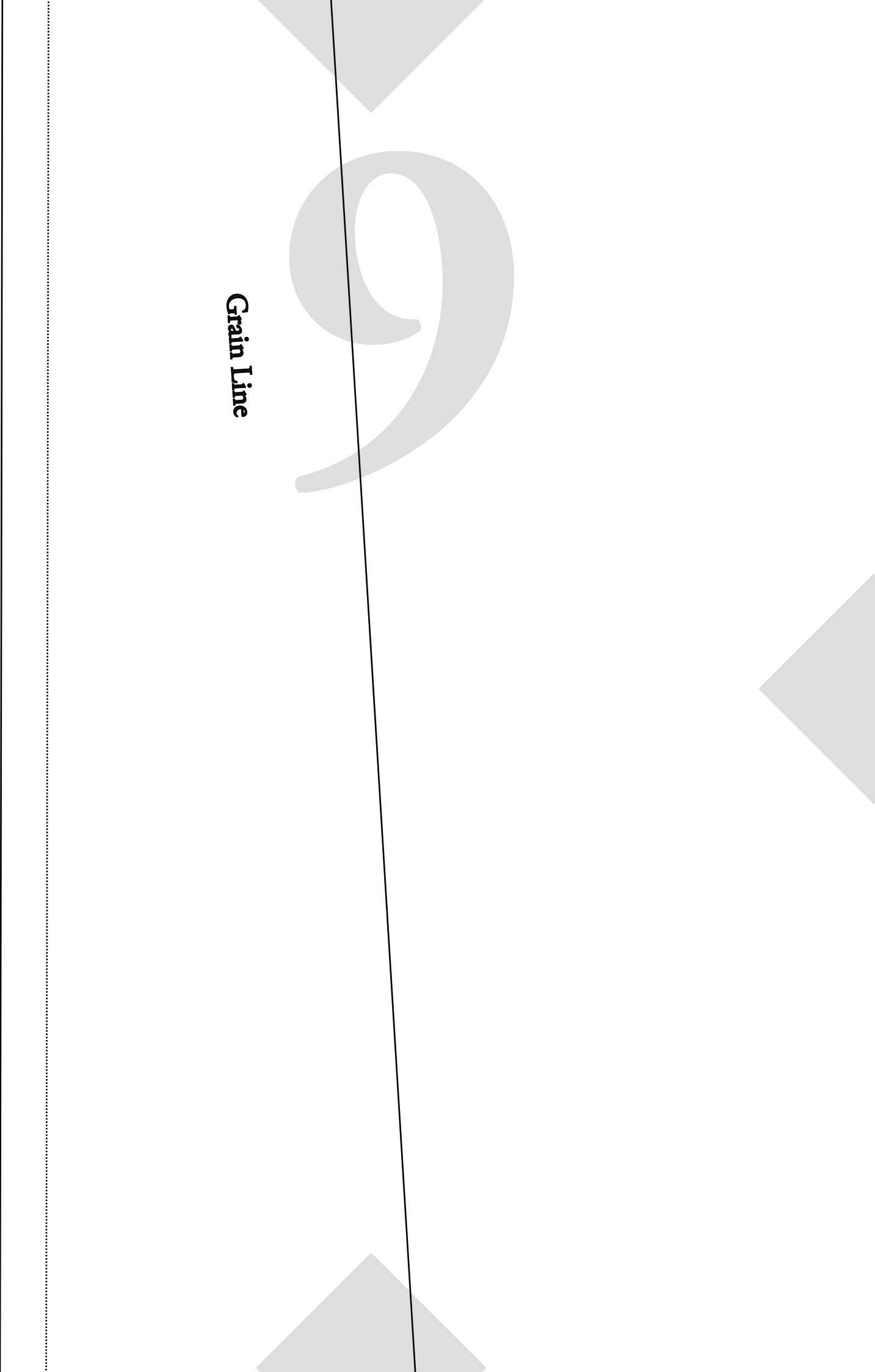
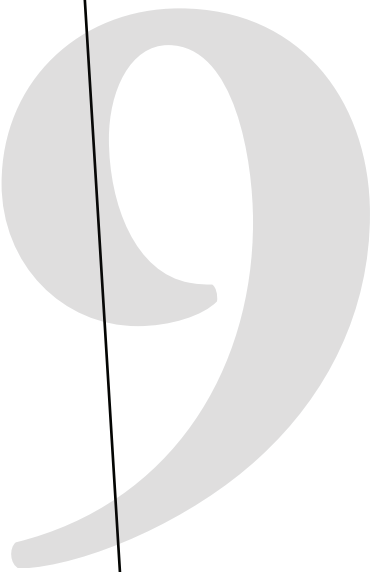

10

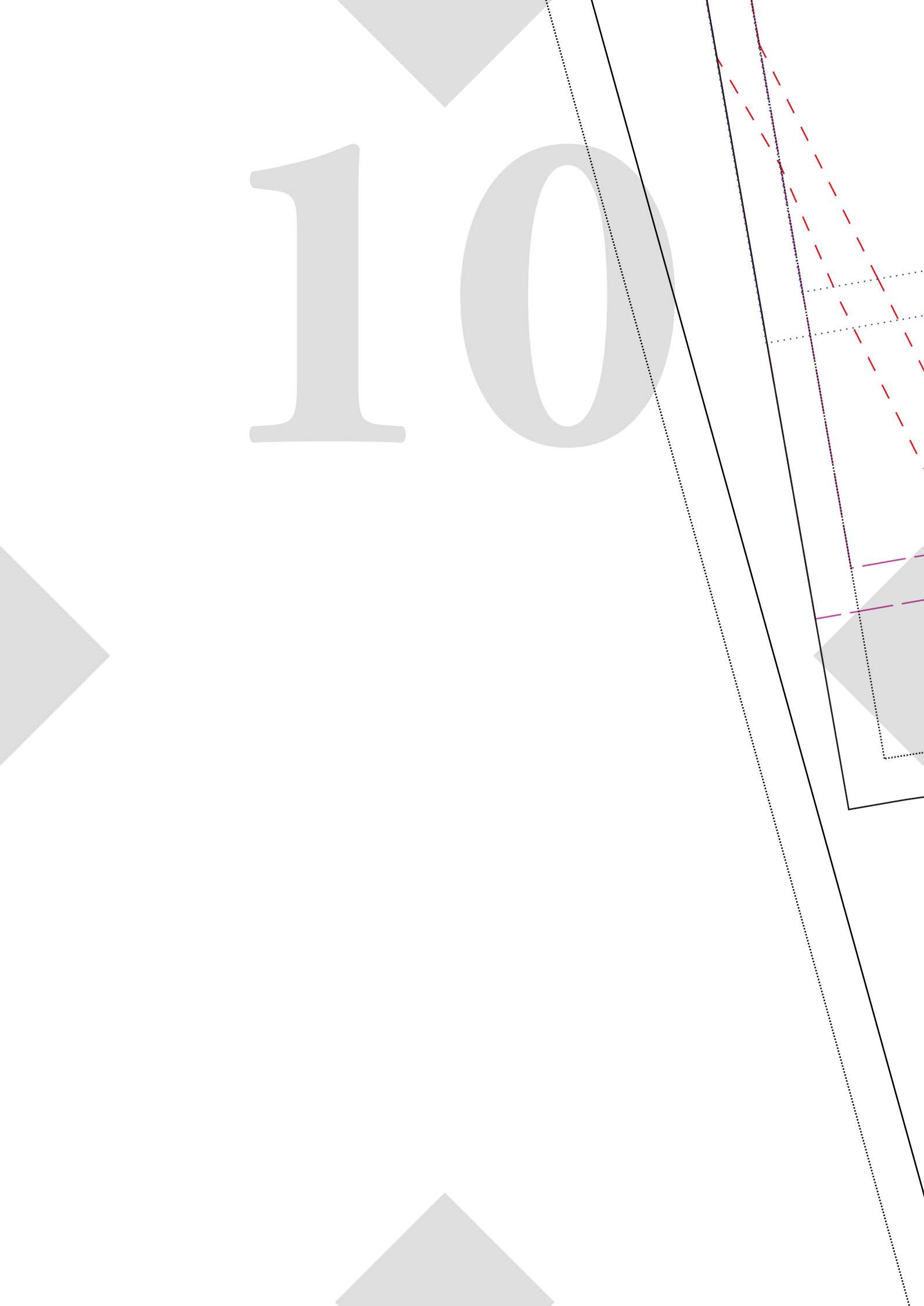

FRONT FACING
SIZE 8

ROSSI & FREDY

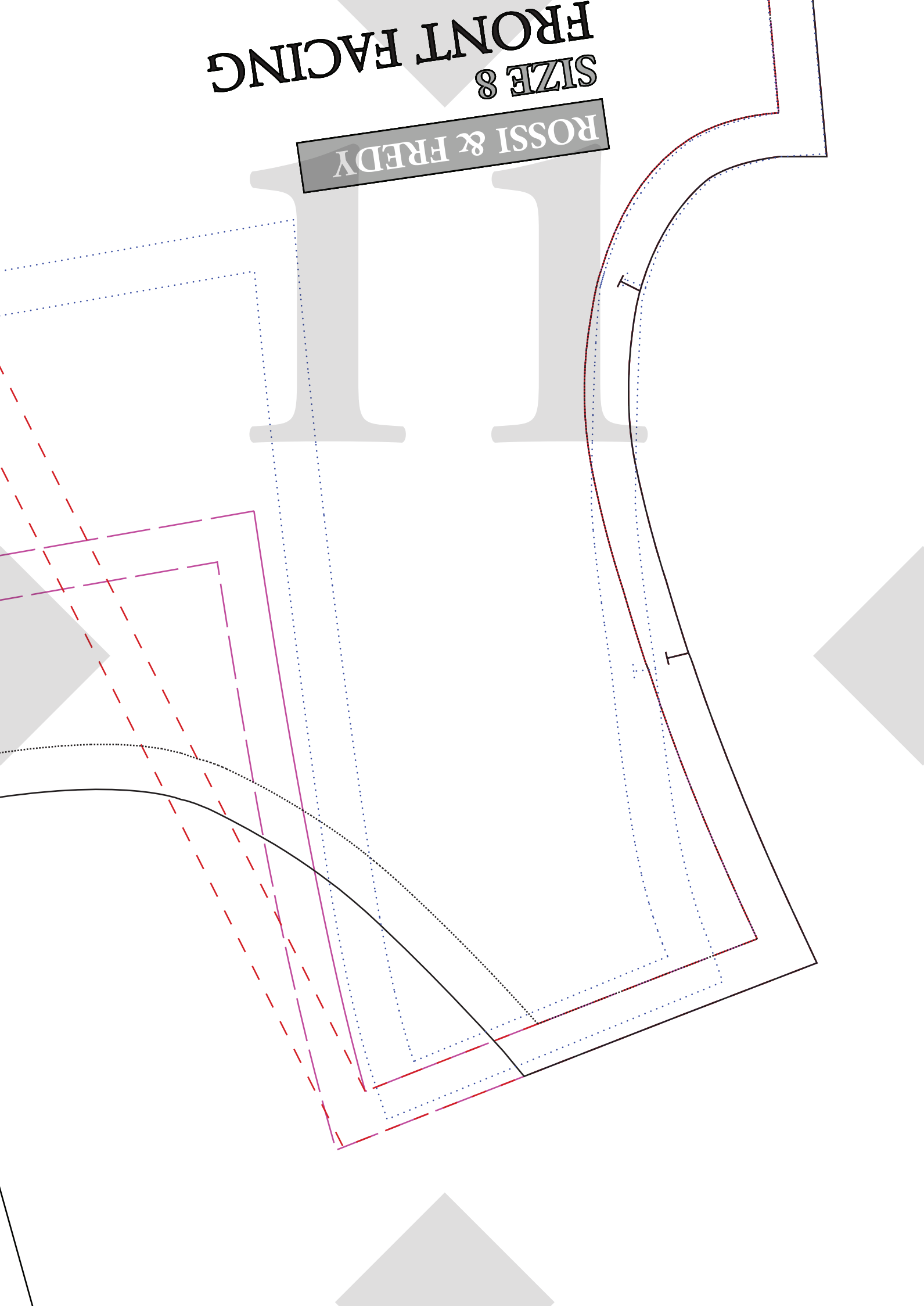

1 2

Grain Line

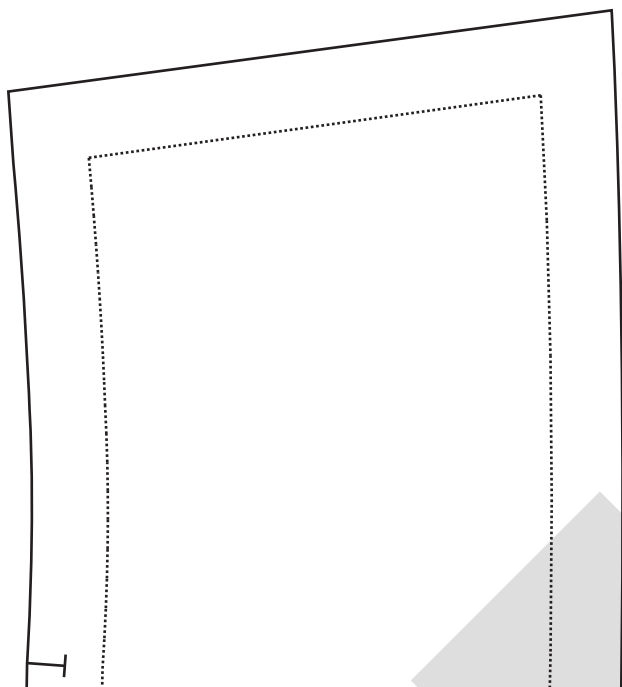

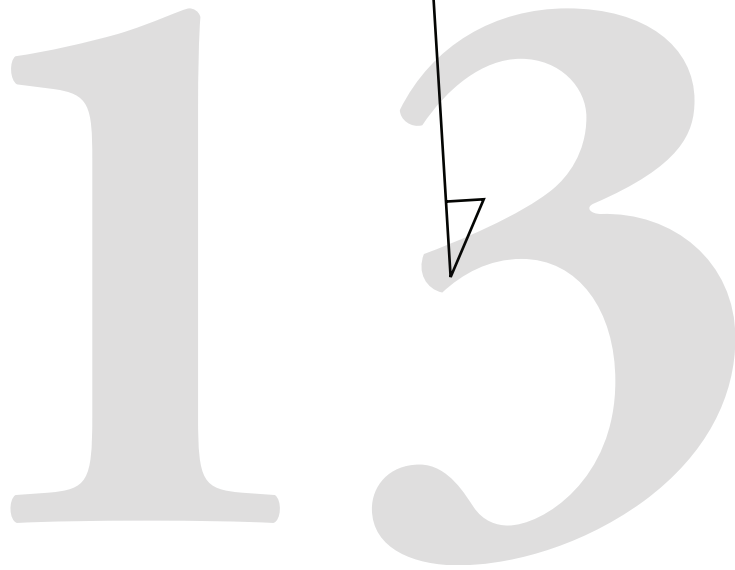

13

For Height 150 - 160cm

For Height 161 - 170cm

For Height 171cm+

For Height 171cm+ (Extra Long)

14

15

16

ROSSI & FREDY

SIZE 8

**CENTRE
FRONT MAIN #2**

Deep Square Neckline

Details:

**Connect Pattern Piece to
CFront #1 at notches below.**

Once connected:

**Refer to CENTRE FRONT #1
for cutting instructions**

Seam Allowance included:

1cm (3/8")

Fold Line / Grain line

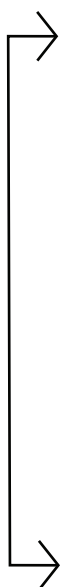

17

ROSSI & FREDY

18

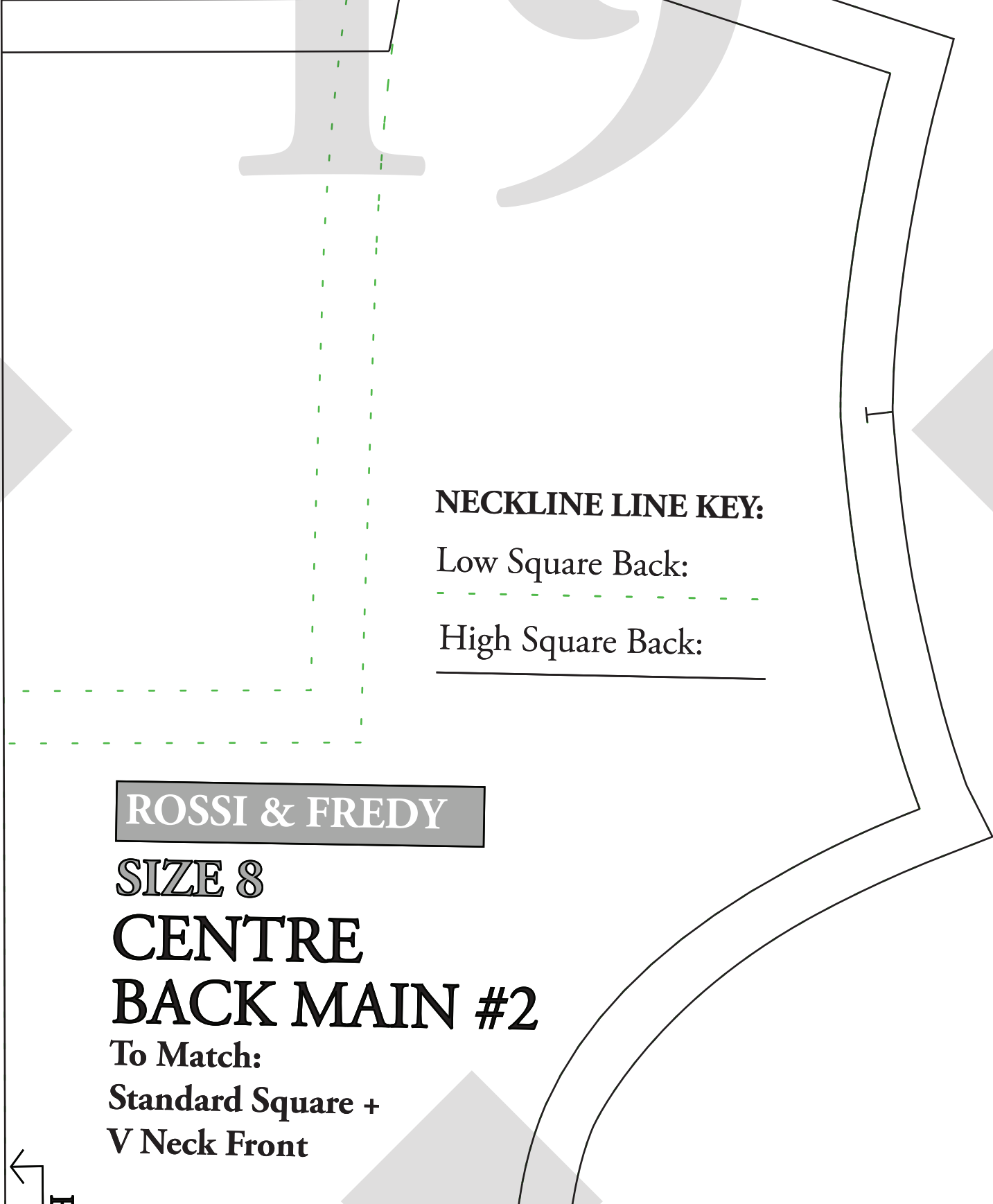
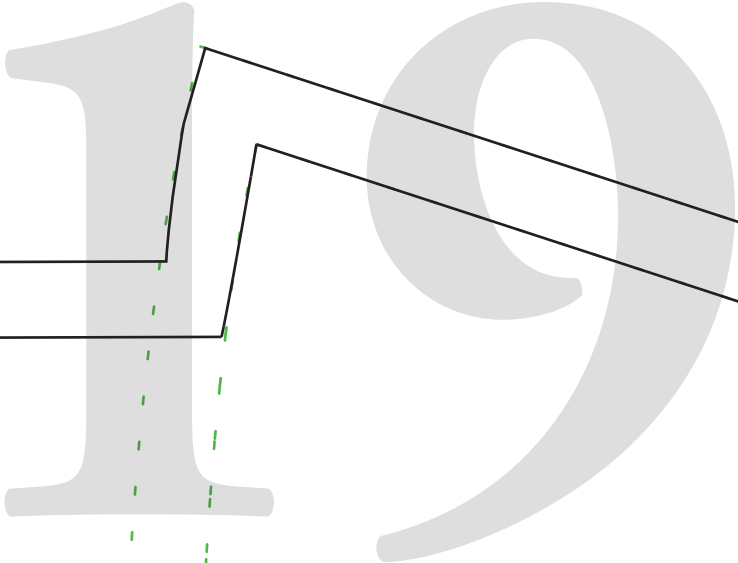

NECKLINE LINE KEY:

Low Square Back:

High Square Back:

ROSSI & FREDY

SIZE 8

**CENTRE
BACK MAIN #2**

To Match:

**Standard Square +
V Neck Front**



▼ TO MATCH DEEP SQUARE BACK BACK BODICE OPTION



SIZE 8
CENTRE
BACK MAIN #2

To Match:
Low Square back
To Match:
Deep Square Front

Details:
Connect Pattern Piece to
Back #1 at notches below.
Once connected:
Refer to CENTRE BACK #1
for cutting instructions
Seam Allowance included:
1 cm (3/8")

Fold Line / Grain line

ROSSI & FREDY

SIZE 8

CENTRE FRONT MAIN #1

Details:

Connect Pattern Piece to CF #2
at notches at top of pattern piece

Once connected:

Cut x1 on FOLD

Seam Allowance included: 1cm (3/8")

← Optional Leg
Split notch



SIZE 8

CENTRE BACK MAIN #1

Details:

Connect Pattern Piece to CB #2
at notches at top of pattern piece

Once connected:

Cut x1 on FOLD

Seam Allowance included: 1cm (3/8")



Fold Line / Grain line

Details:

Connect Pattern Piece to CBack #1 at notches below.

Once connected:
Refer to CENTRE BACK #1 for cutting instructions
Seam Allowance included:
1cm (3/8")

^ TO MATCH STANDARD SQUARE & V NECK FRONT BACK BODICE OPTIONS

Details:
Cut x1 Pair (x2 pieces in total)
Seam Allowance included:
1cm (3/8")

Grain line

- For Deep Square Front: Low Square Neck
- For V Neck + Standard Square Front: High Square Neck
- For V Neck + Standard Square Front: Low Square Neck
- For Boat Neck Front: Low Square Neck

NECKLINE LINE KEY:

BACK FACING
SIZE 8

ROSSI & FREDY

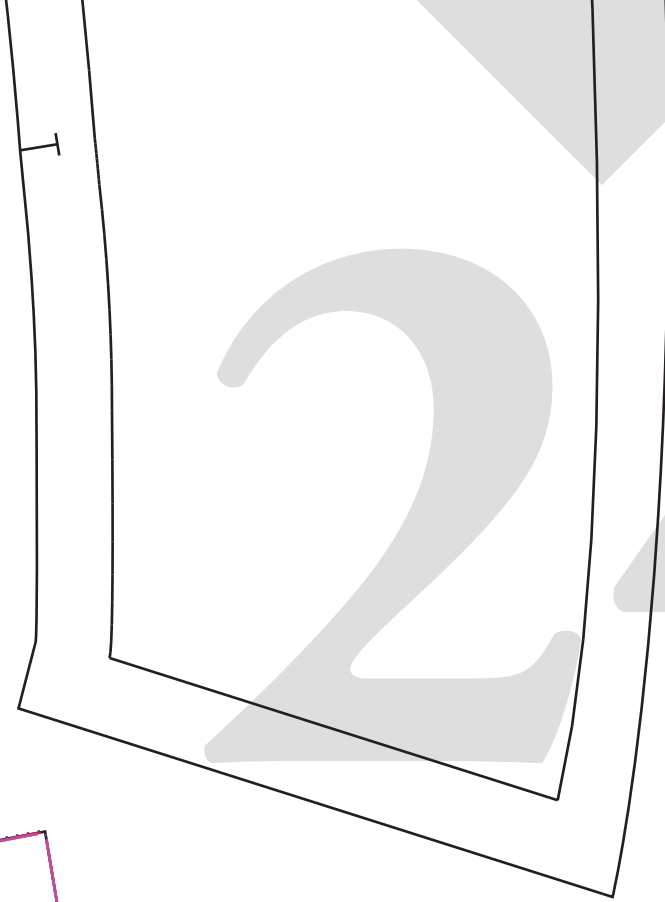

4

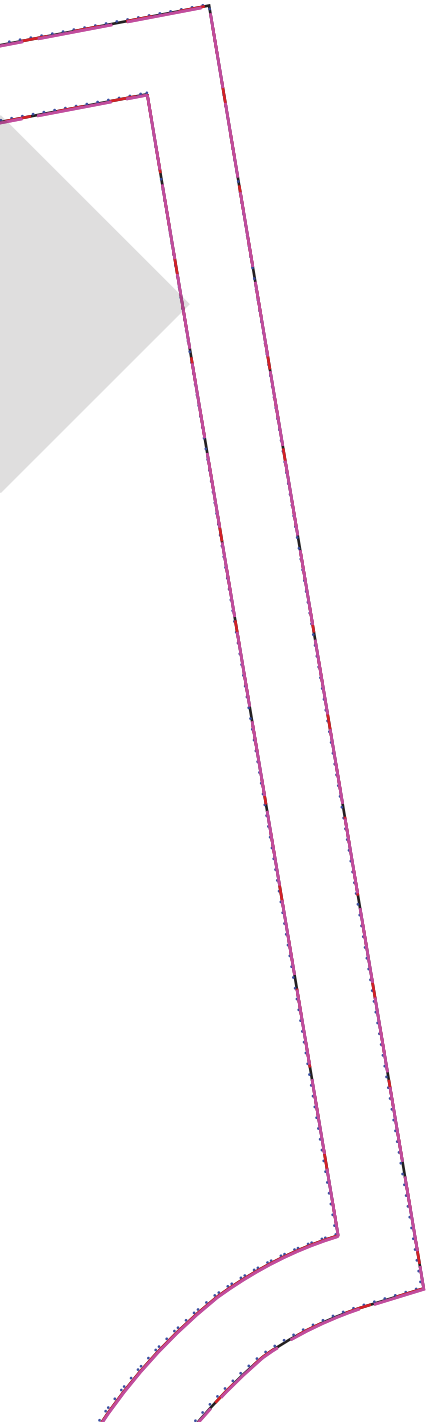

25

Fold Line / Grain line



Fold Line / Grain line



26

27

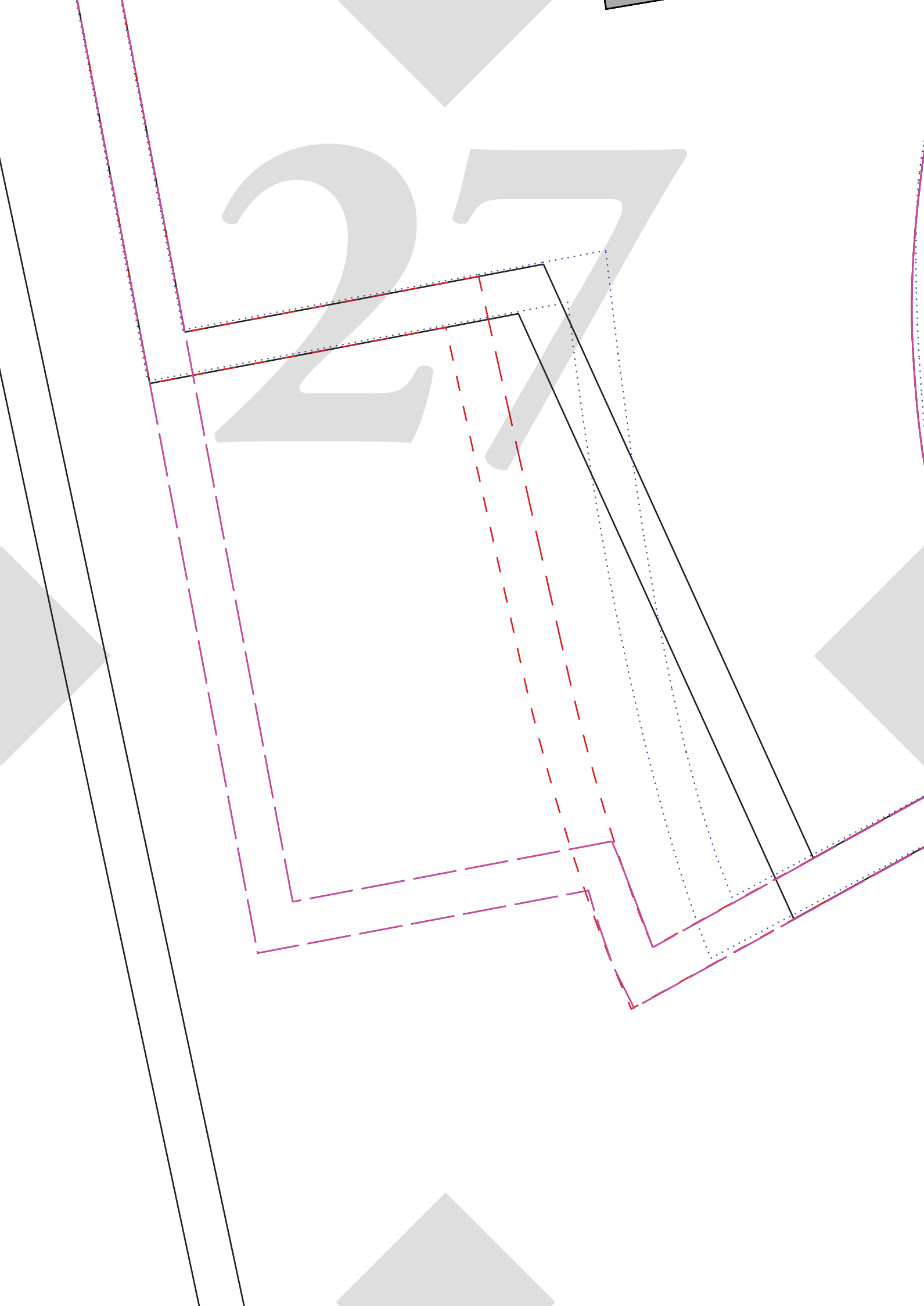

28

^ TO MATCH BOAT NECK FRONT BACK BODICE OPTION

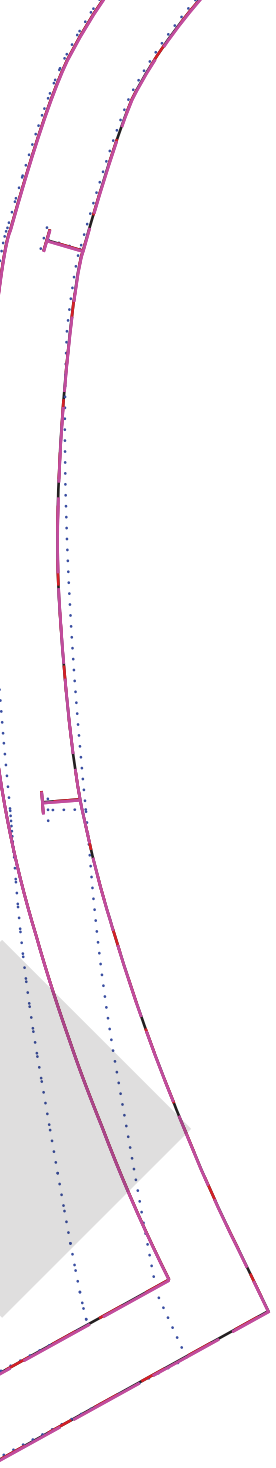

Details:
Connect Pattern Piece to
CBack #1 at notches below.

Once connected:
Refer to CENTRE BACK #1
for cutting instructions
Seam Allowance included:
1cm (3/8")

Fold Line / Grain line

A diagram of a pattern piece showing a curved neckline with two notches. A vertical line indicates the fold line, and a horizontal line indicates the grain line. An arrow points to the right along the grain line.



29

For Height 150

For Height 16

For Heig

For Height 171cm

30

- 160cm

For Height 150 - 160cm

1 - 170cm

For Height 161 - 170cm

ght 171cm +

For Height 171cm+

+ (Extra Long)

For Height 171cm+ (Extra Long)

31

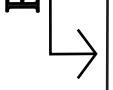

Boat Neck Front
To Match:

Low Square back

BACK MAIN #2

CENTRE

SIZE 8

ROSSI & FREDY

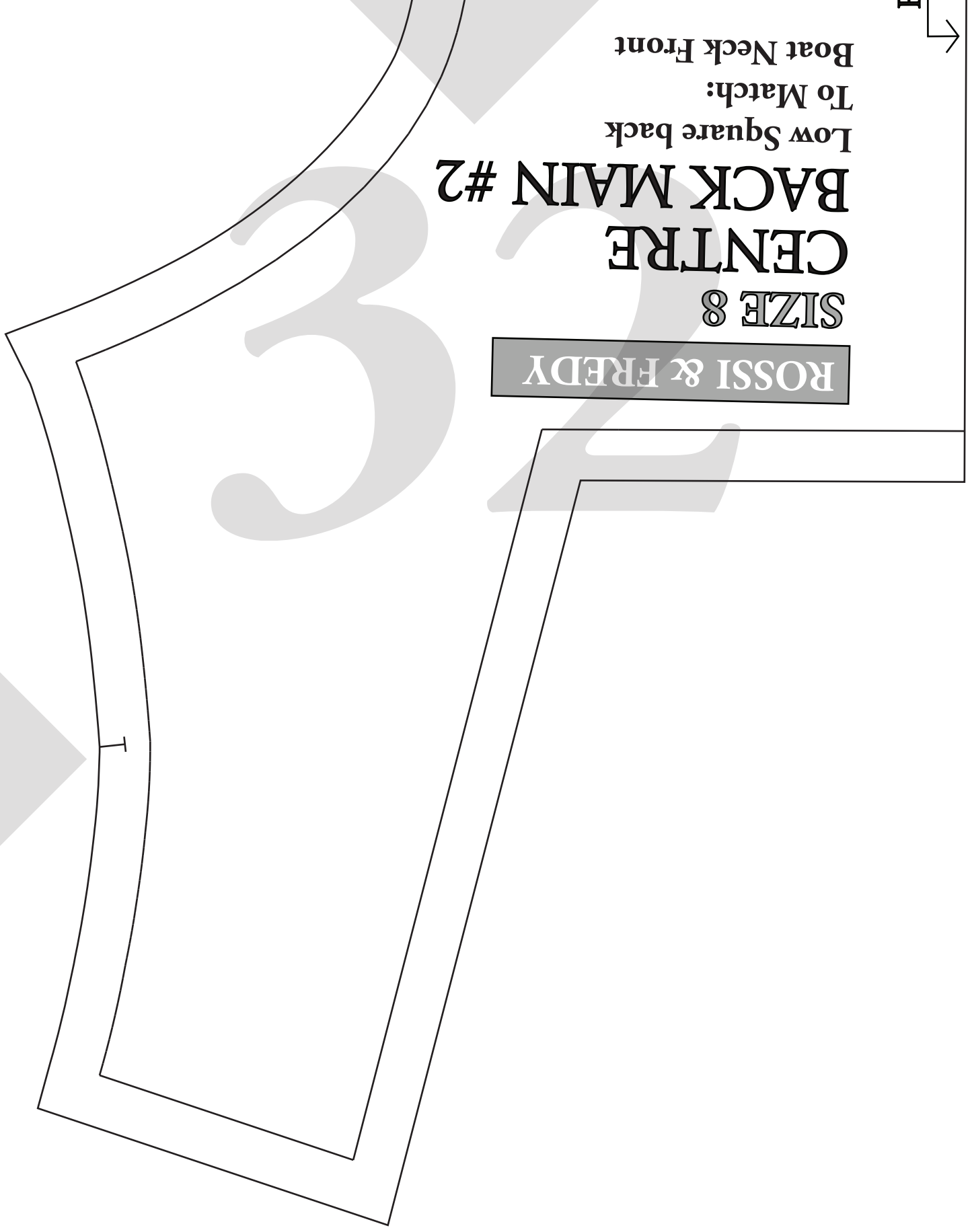



33

3

ROSSI & FREI

SIZE 8

SHORT PUFF
SLEEVE CUFF

Fold Line

Grain Line

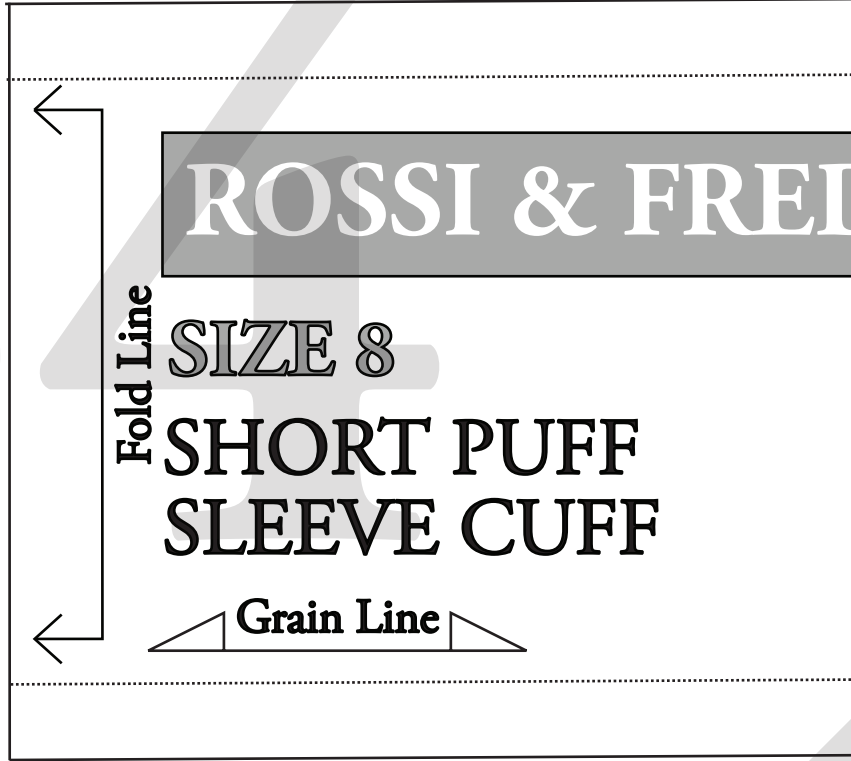
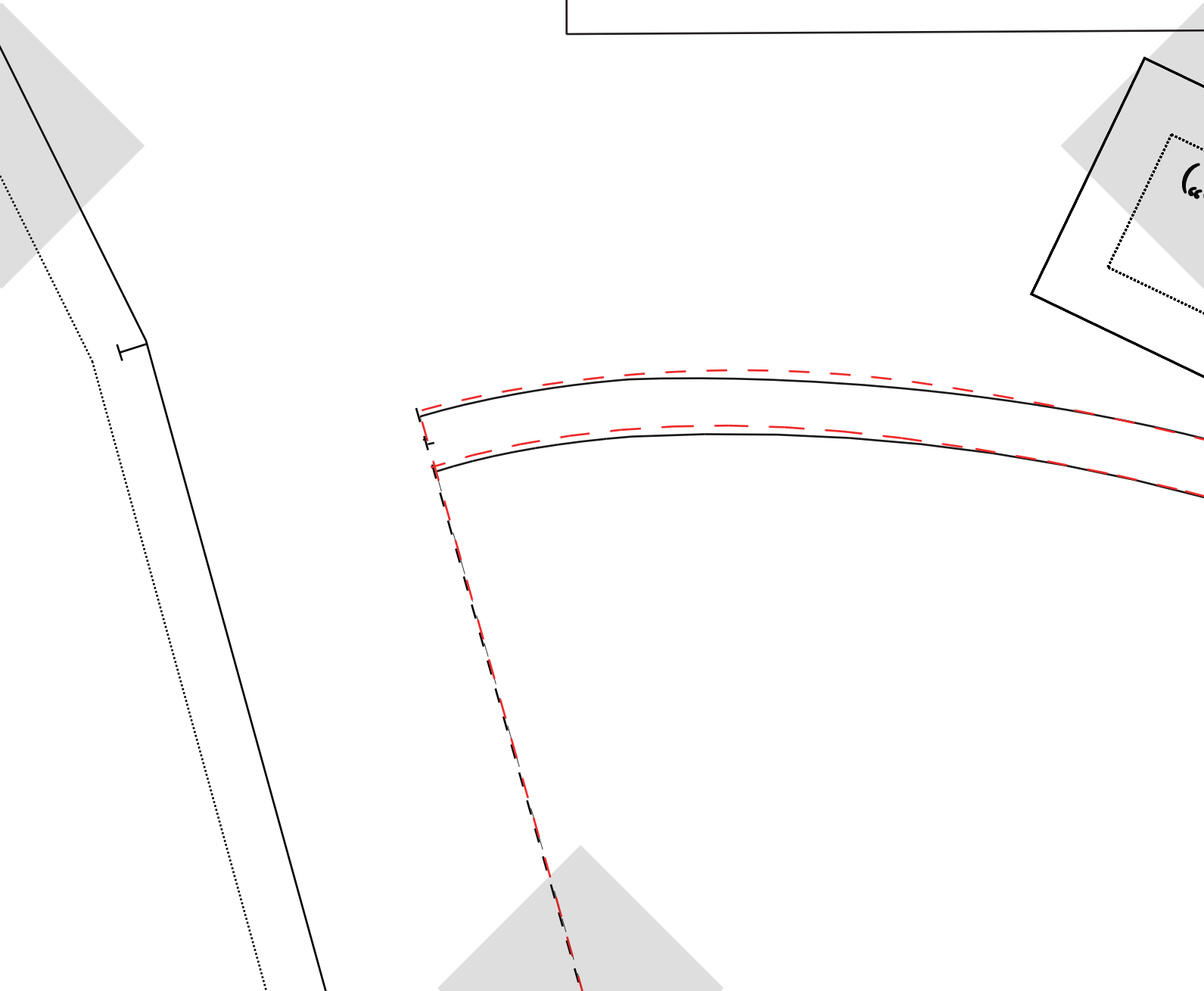
A rectangular diagram representing a fabric piece. It features a solid top and bottom edge, and a vertical line on the left side. Two horizontal dotted lines are positioned near the top and bottom edges. A vertical double-headed arrow on the left side is labeled 'Fold Line'. A horizontal double-headed arrow at the bottom is labeled 'Grain Line'. The text 'ROSSI & FREI', 'SIZE 8', and 'SHORT PUFF SLEEVE CUFF' is centered within the rectangle.

BY

35

Details:
Cut x2 on Fold
(Measure upper arm to compare
See beginning of sewing instructions)
Seam Allowance included: 1cm (3/8")

Details:
Cut x 2
Seam Allowance: 1cm (3/8")

CK TIE

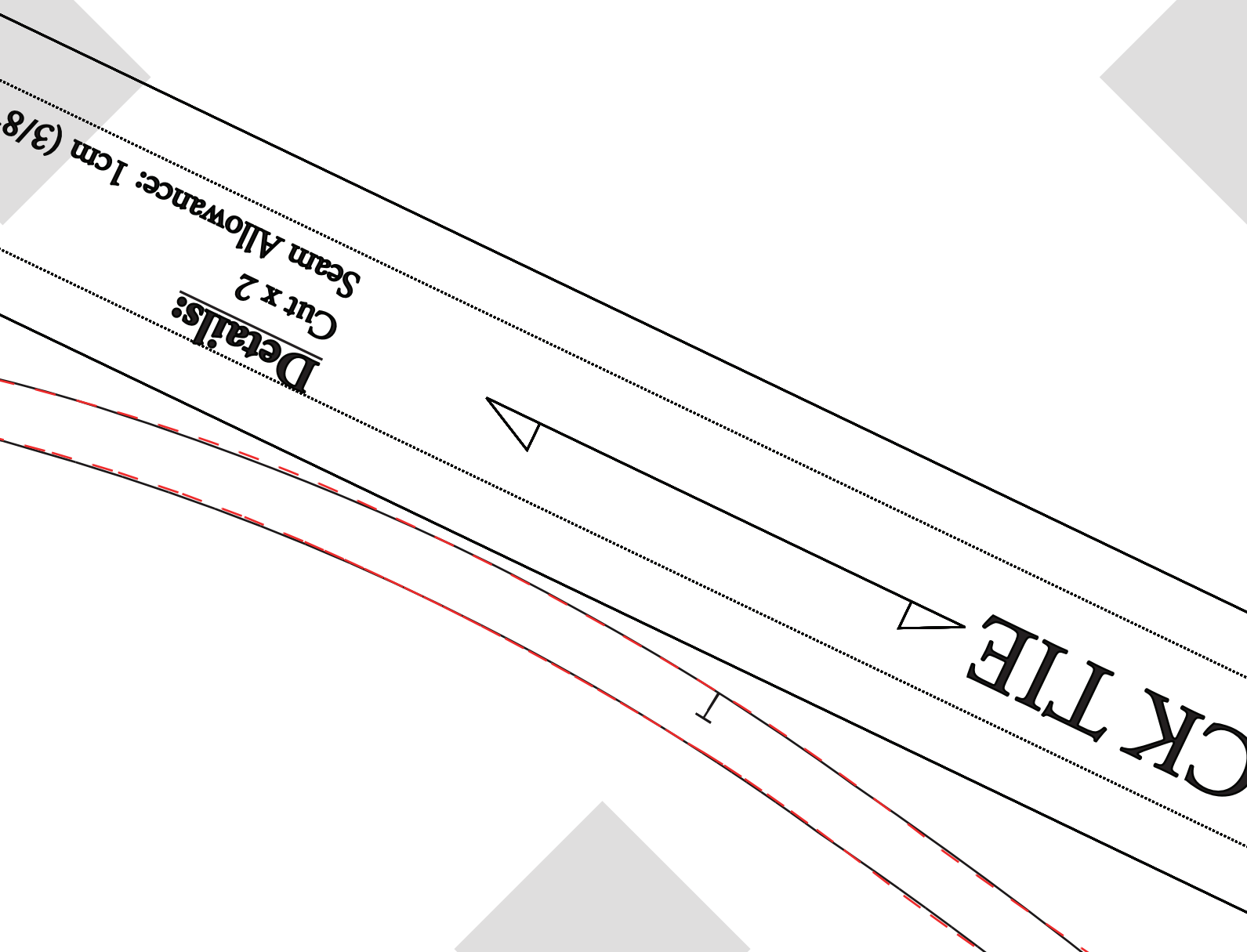

ROSSI & FREDY

POCKET BAG

Details:

Cut x 4

Seam Allowance: 1cm (3/8")

Grain Line

BACK NECK

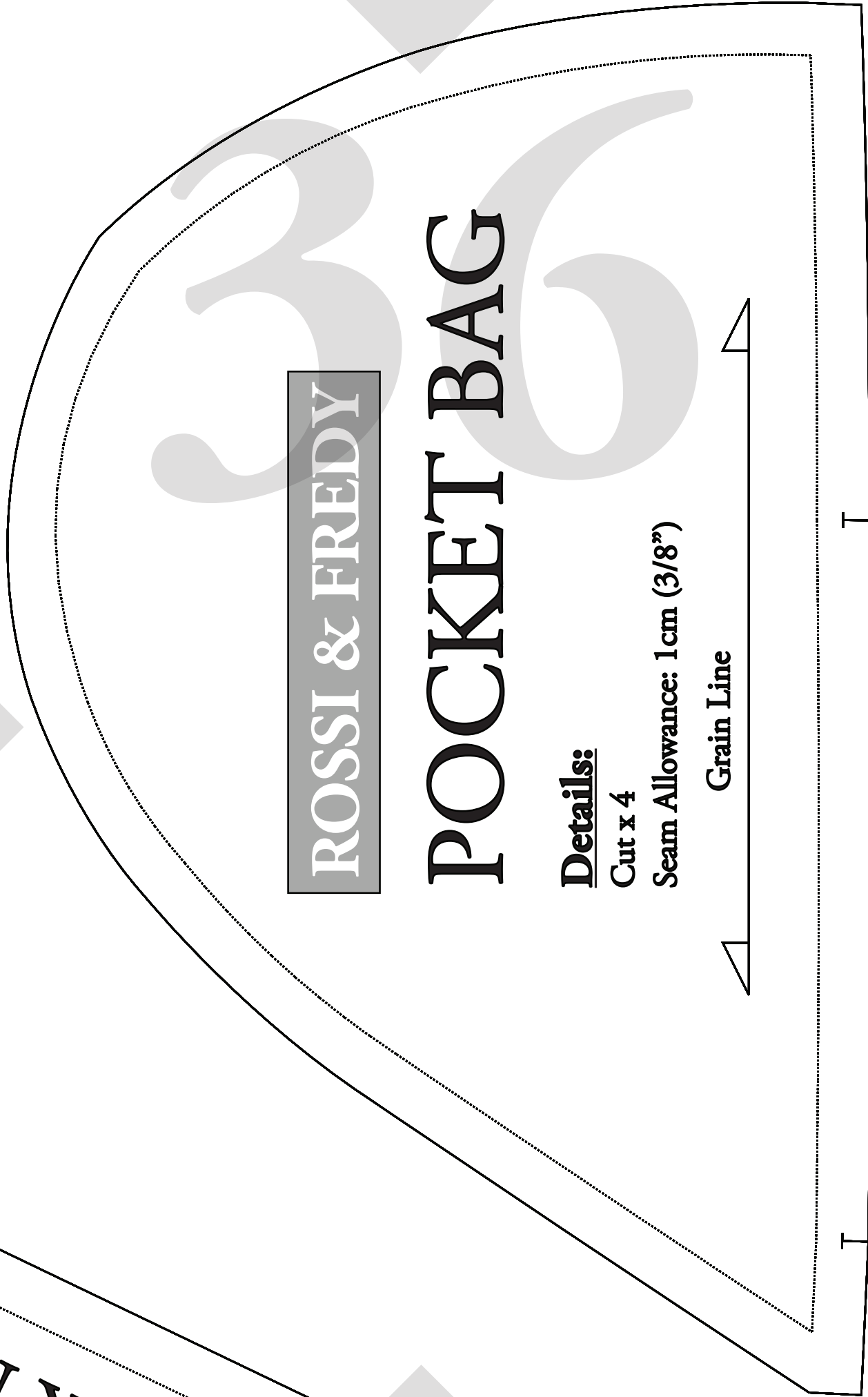

ROSSI & FREDY

SIZE 8

SIDE BACK #1

Details:

**Connect Pattern Piece to #2
at notches at top of pattern piece**

Once connected:

Cut x 1 Pair (2 pieces all up)

Seam Allowance included: 1cm (3/8")

38

at & FREDY

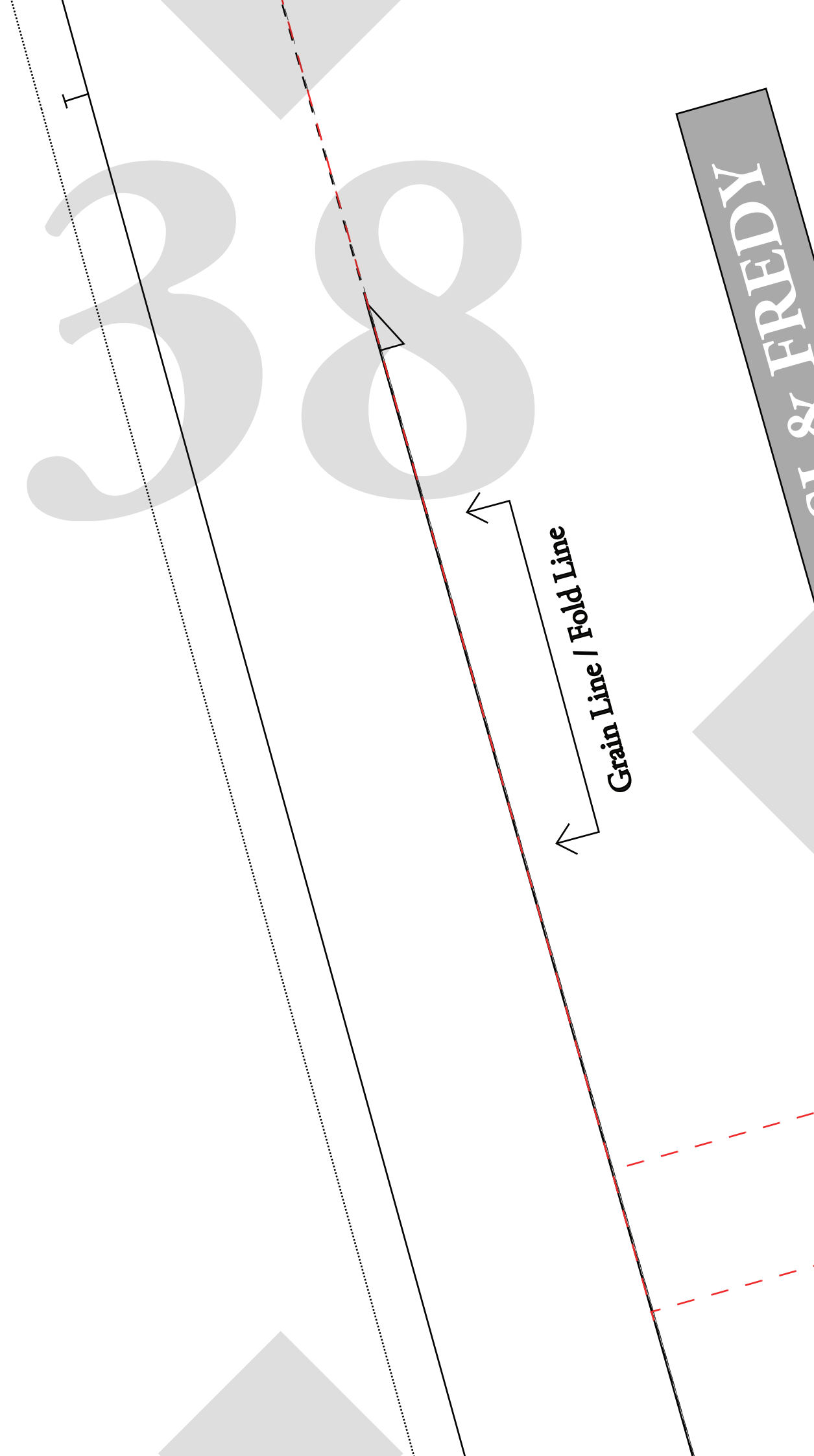

Grain Line / Fold Line

ROSSI &

SIZE 8

SHORT PUFF SLEEVE

Details:

Cut x 2 on fold

Seam Allowance included: 1cm (3/8")

LINE KEY

SHORT PUFF SLEEVE:

ROSSI & FREDY

40

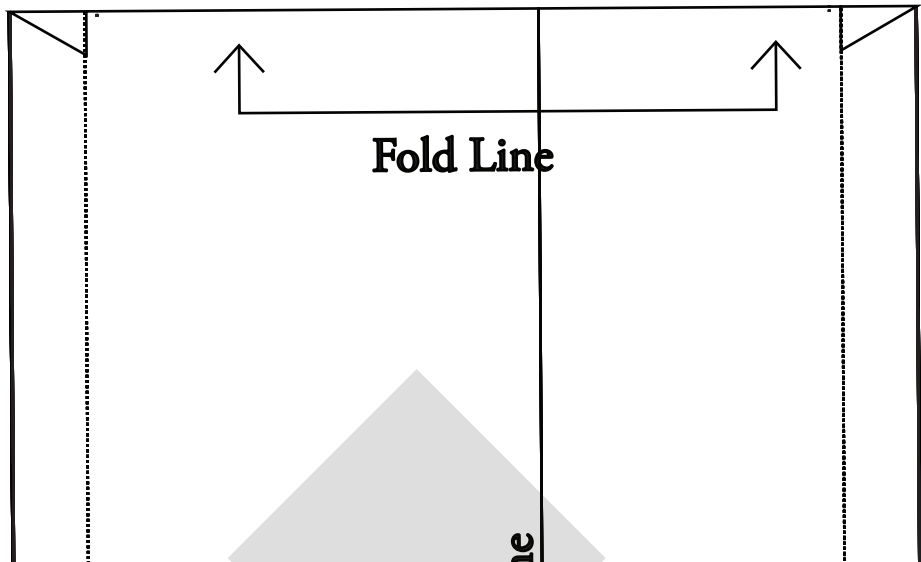
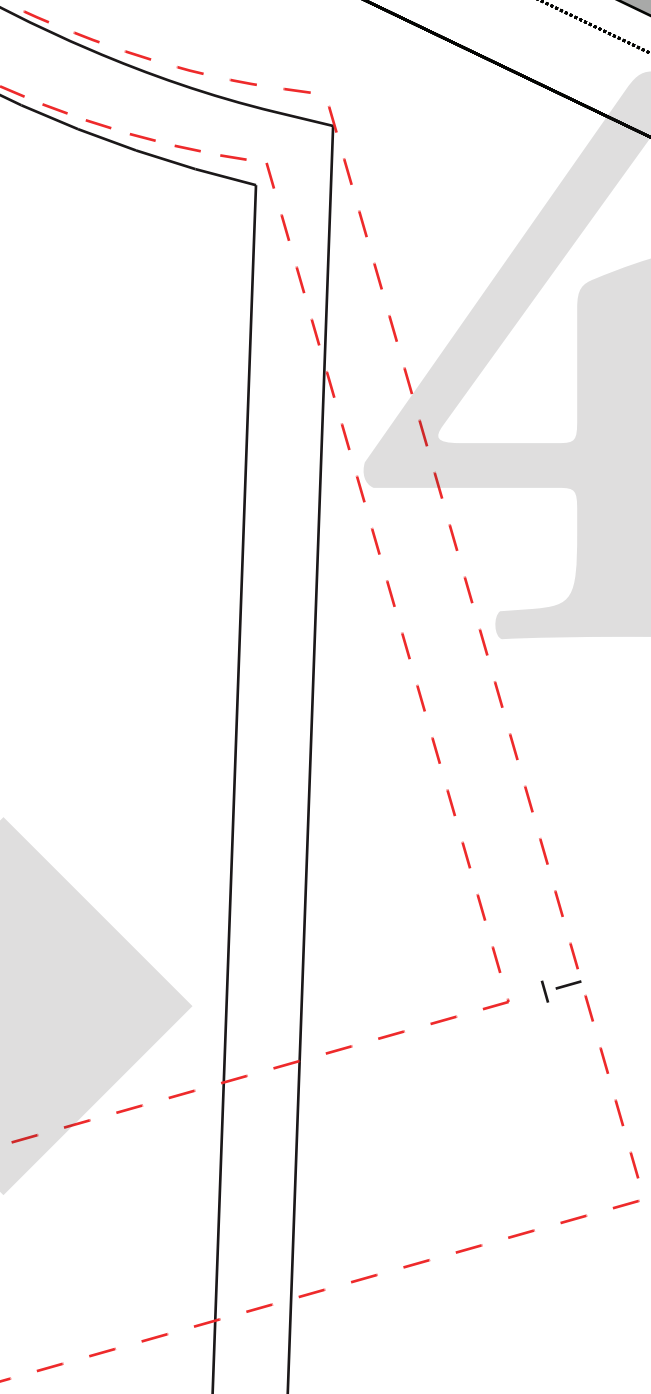

Fold Line

ne

41

Grain Line



42



Grain Line / Fold Line

ROSSI & FREDY

LONG SHIRRED SLEEVE

SIZE 8

Details:

Cut x 2 on fold

Seam Allowance included: 1 cm (3/8")

LINE KEY

LONG SHIRRED:

& FREDY

SCARF

Include scrunchie section
Included: 1cm (3/8")

ROSSI & FREDY

SCRUNCHIE

Details:

Cut x 1 on fold

Seam Allowance included: 1cm (3/8")

Grain Lin



45

For Height 150 - 160cm

For Height 161 - 170cm

For Height 171cm+



For Height 171cm+ (Extra Long)

46

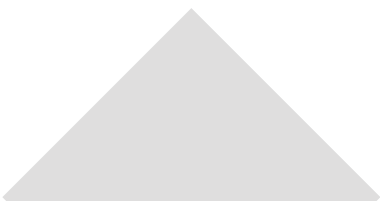
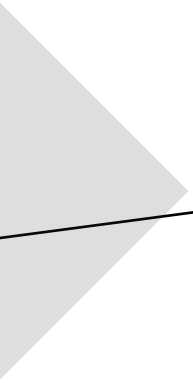

FREDY / ROSSI WRAP

SIZE 6 - 14

STANDARD WAIST WRAP WING

Cut x2 Pairs (x2 up this way, x2 with this side flipped over)
Seam Allowance included: 1cm (3/8")

GRAINLINE

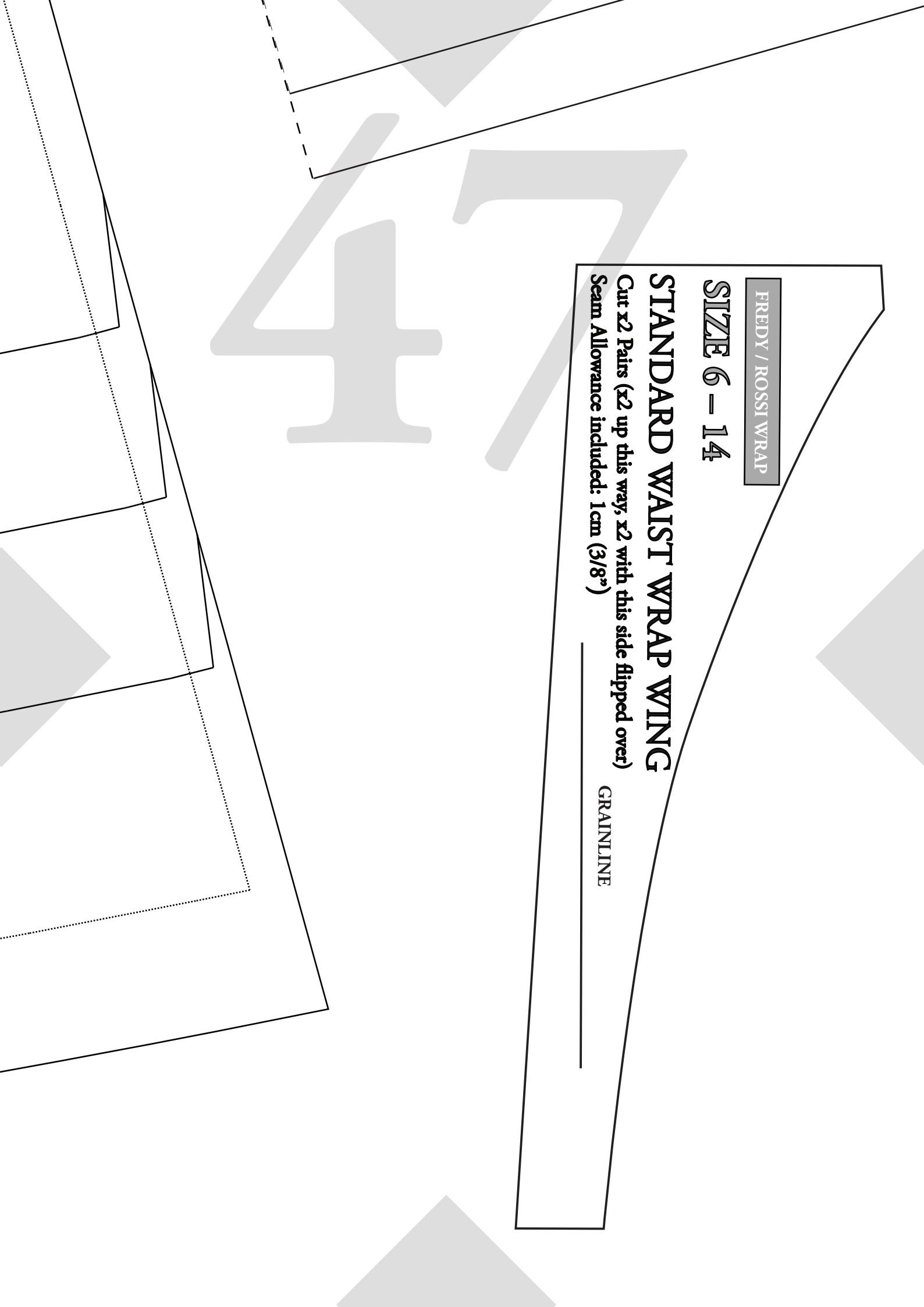

ROSSI &

HEAD

Details:

Cut x 1 on fold. Inc

Seam Allowance inc

SIDE BACK #2
SIZE 8

Details:

Connect Pattern Piece to Back #1
at notches below.

Once connected:

Refer to SIDE BACK #1 for cutting
instructions
Seam Allowance included: 1cm (3/8")

Grain Line

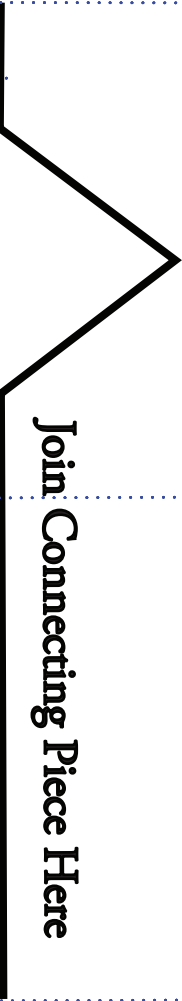

Join Connecting Piece Here

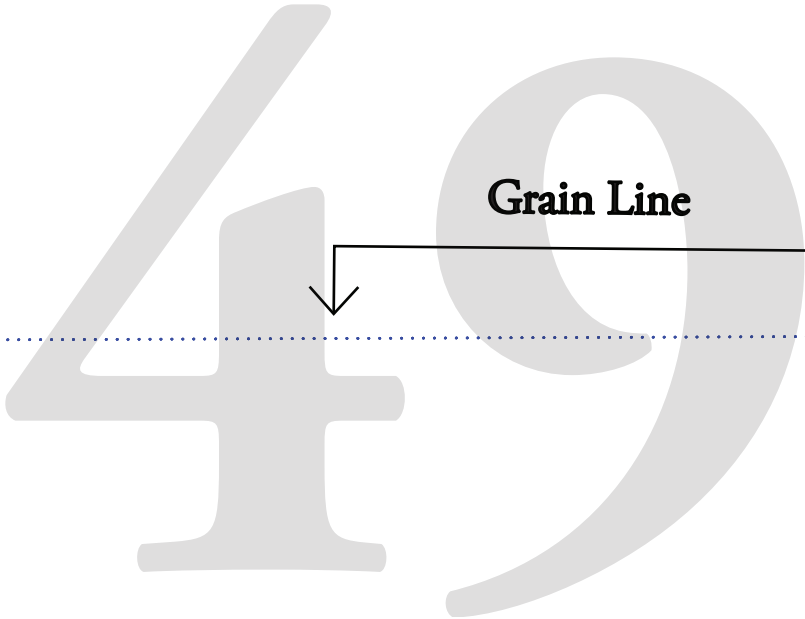

Grain Line

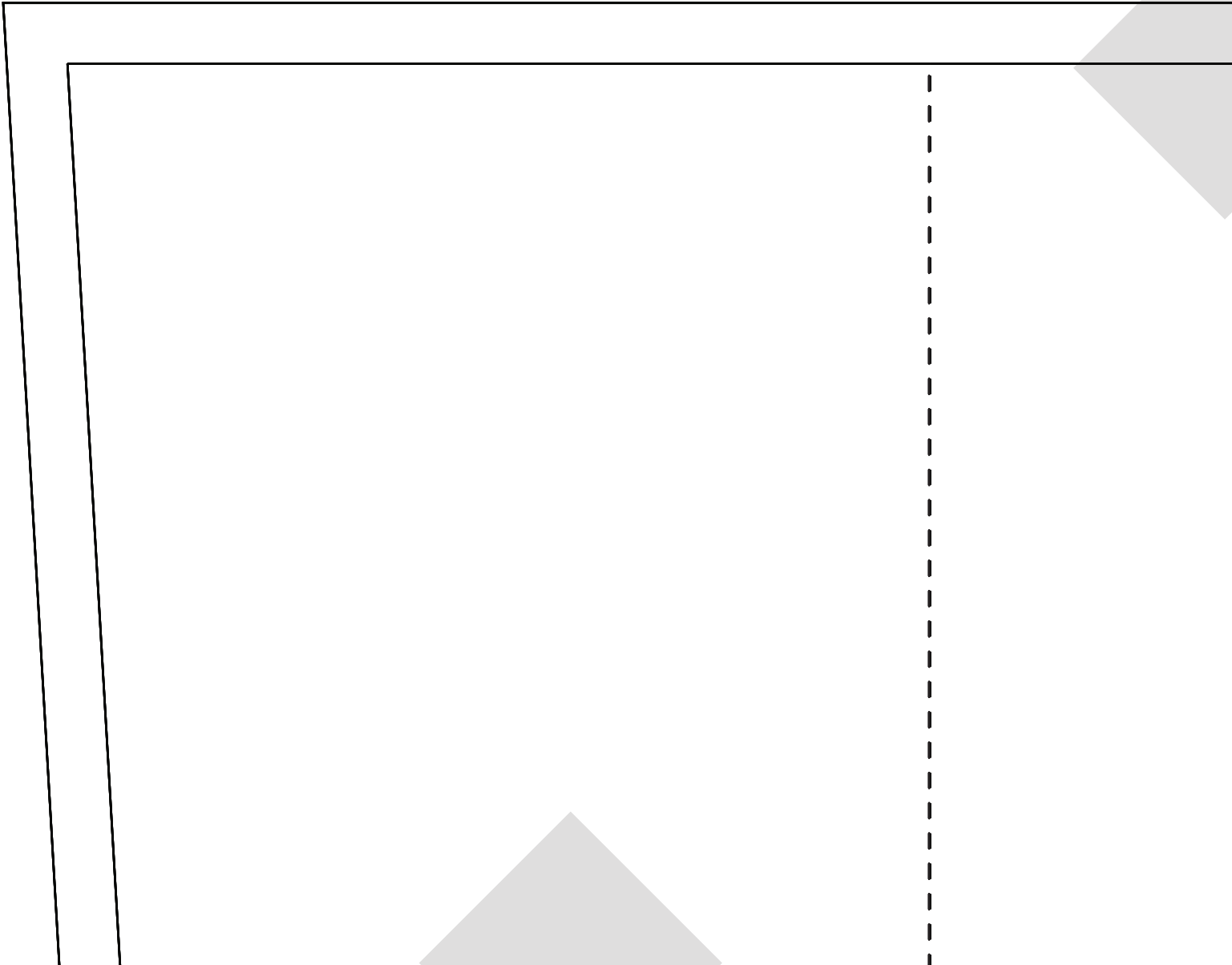

SIZE 6 - 14

TWO TONE WAIST WRAP

#2

Details:

Connect Pattern Piece to #1

See Wrap #1 once connected

for cutting instructions

Seam Allowance included: 1 cm (3/8")

51

52

Join Connecting Piece Here

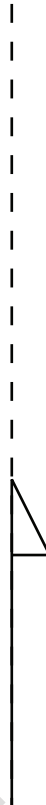

53

Grain Line / Fold Line

ROSSI & FREDY

SIZE 6 - 14

STANDARD

THU

54

ROSSI & FRE

SIZE 6 - 14

STANDAL

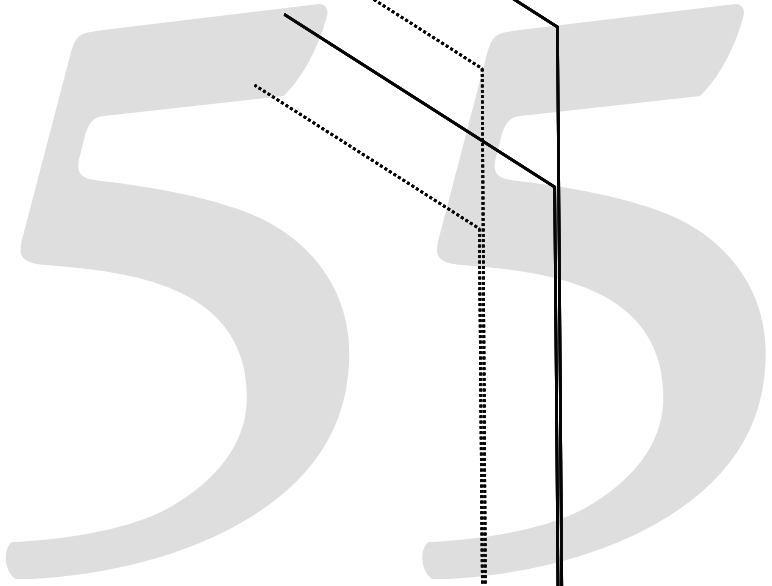

Grain Line / Fold Line



RDY

RD, THIN

56

Grain Line

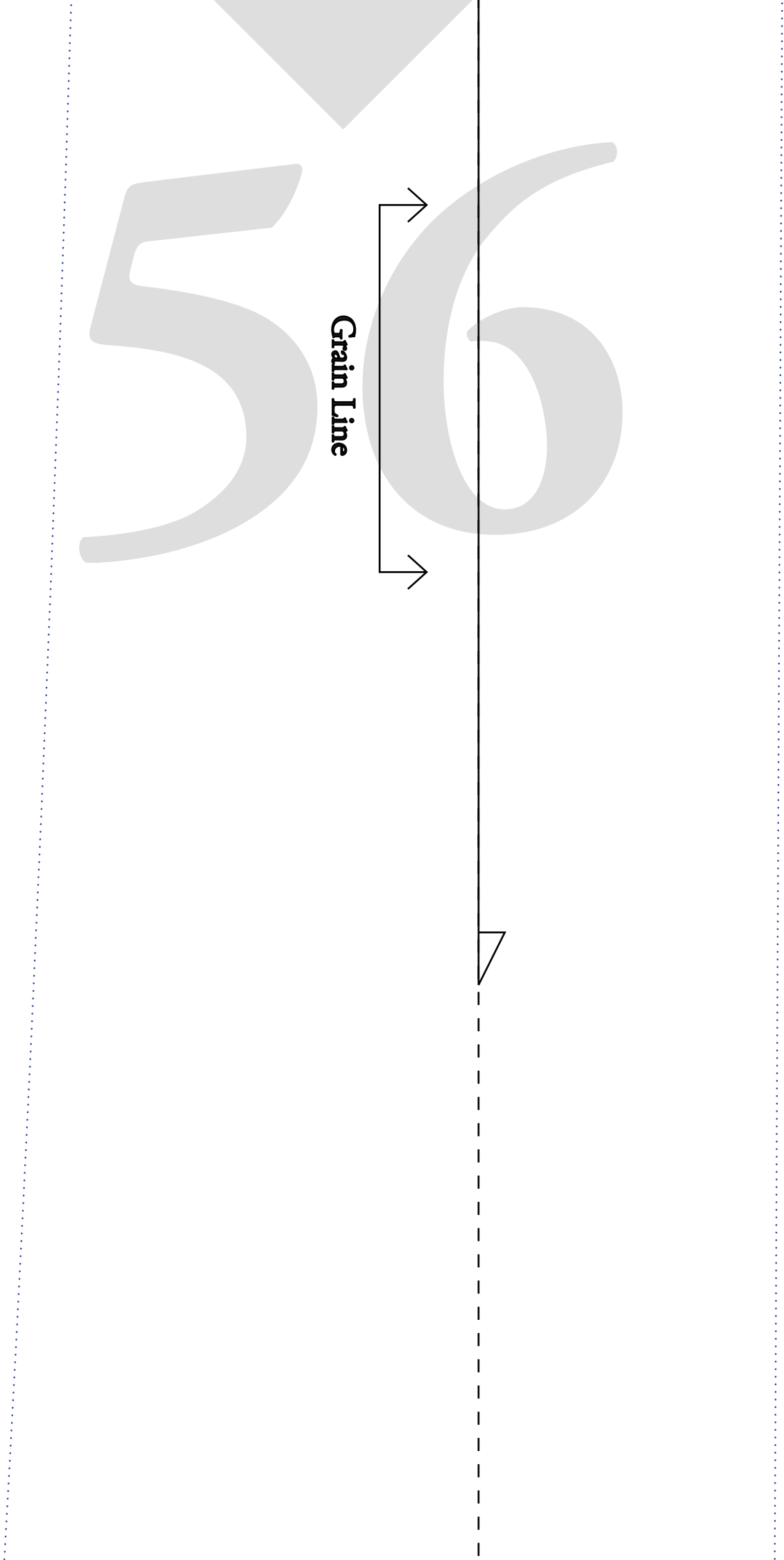

STANDARD + TH WAIST WRAP #1

Details:

Connect Pattern Piece to #2

Once connected:

Cut x 2

Seam Allowance included: 1cm (3/8")



Join Connecting Piece Here

IN

STANDARD WAIST W

58

Details:

Connect Pattern Piece to #1

See Wrap #1 once connected for c

Seam Allowance included: 1cm (3

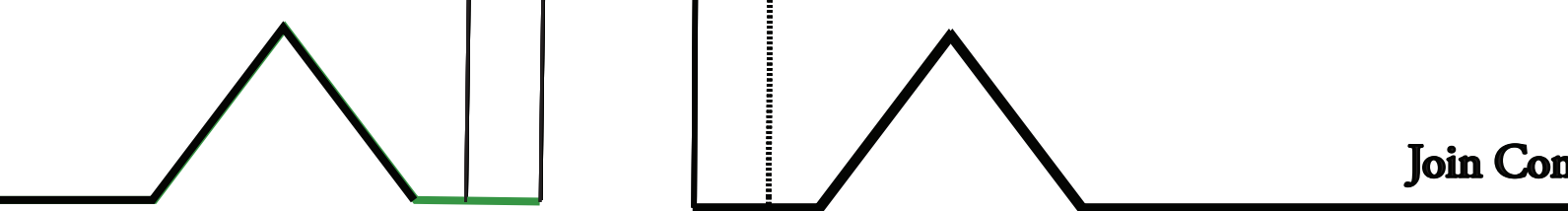

Join Con

WOOD + THIN

TRAP #2

Cutting instructions
(1/8")

50

Connecting Piece Here

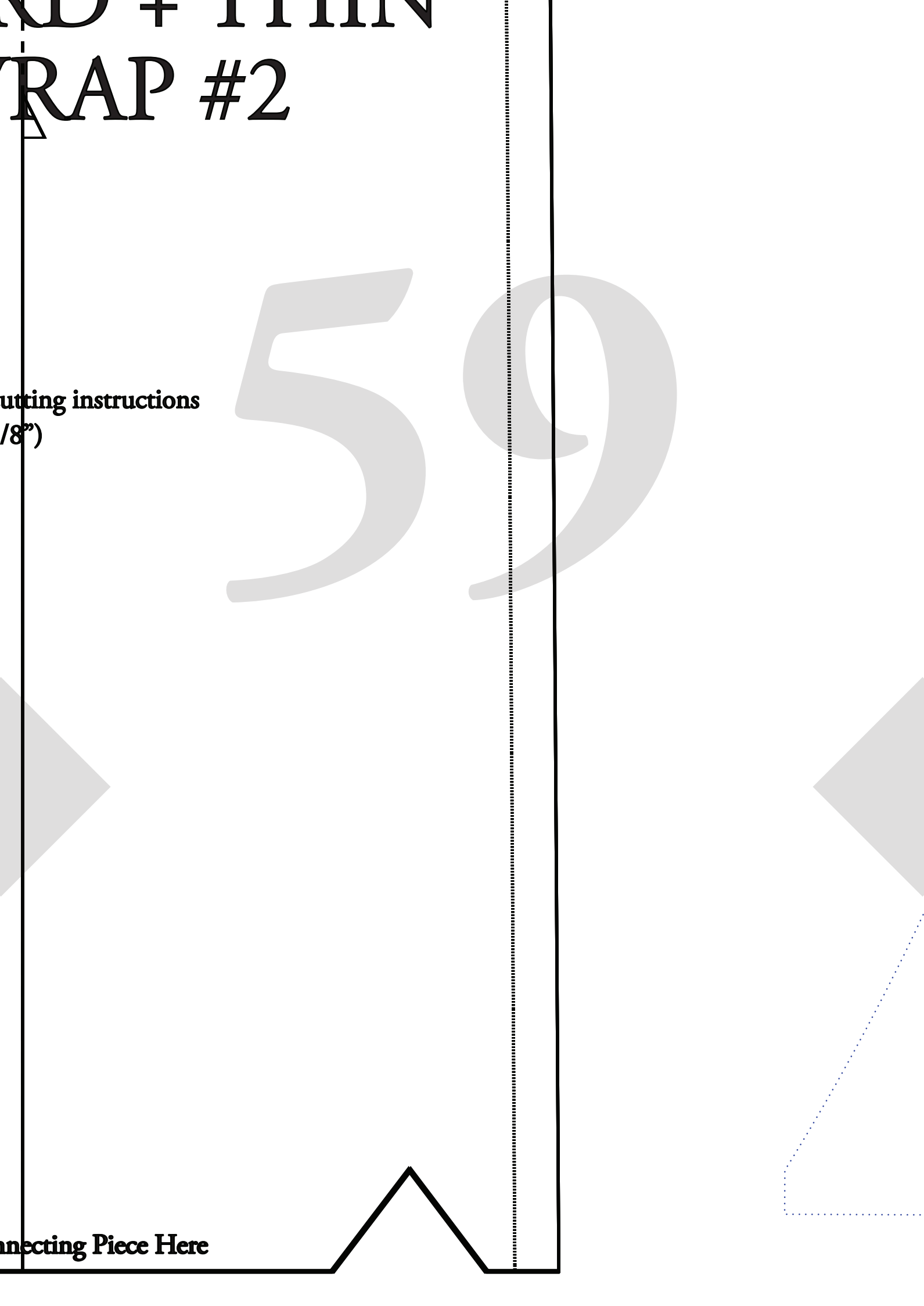

ROSSI & FREDY

SIZE 6 – 14

TWO TONE WAIST WRAP #1

Details:

Connect Pattern Piece to #2

Once Connected :

Cut x 2 in Primary Colour (one pair)

Cut x 2 in Secondary Colour (one pair)

Seam Allowance included: 1cm (3/8")