

A4 PRINTING INSTRUCTIONS

Before you get started on creating your Rossi of Fredy Wrap, make sure to read the below notes so that you can make sure your printer is calibrated and prints the patterns to the correct size.

Before you begin, please make sure you are printing on A4 paper with an A4 printer, not letter paper as the small difference in the paper size can mean your patterns don't print correct. A4 measures 210 x 297mm

1. Select Layers / styles:

Make sure you have gone through the PDF and selected all necessary layers + Customisations that you need for your Rossi / Fredy Wrap in instructions. You can print out all the customisations if you wish to make more variations in future.

2. Print the first three pages as a test print:

We strongly suggest printing the first three pages as a test to make sure everything is set up correctly, to save time, paper and the environment.

When printing in Adobe Acrobat, do as follows:

- File > Print
- Select your printer
- Click 'Pages' and then type '1 - 3' (for test print)
- Click 'Custom Scale' and type '100%'
- Click 'PRINT'

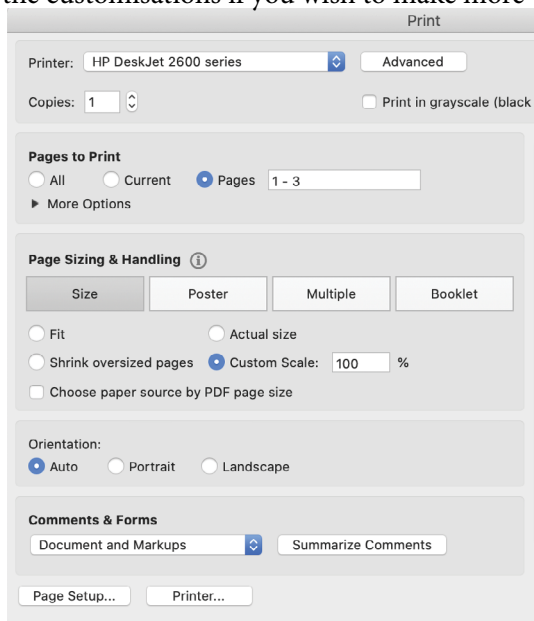

3. Calibrate and measure

When printing, although you would've selected '100%', most common household printers will print with a white border. Don't worry, this won't affect measurements and you **SHOULD NOT** trim the borders. However, to check this is correct for your printer – we have provided two tests of calibration squares.

3a: Single Square Calibration

On the first pattern page, you will see a 5x5cm square and a 1"x1" square. Using your ruler, measure these squares to make sure they (along with your patterns) have printed to the correct scale.

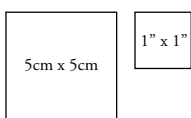

Note: These calibration squares are an example only and are not printed to scale.

3b: Across-Page Diamond Calibration

You will then see a grey diamond split across the first two pattern pages (similar to the below example). Simply measure from one corner of the diamond to the other corner. This should measure 5cm from left point to right point.

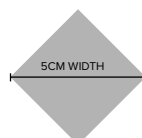

Note: This diamond is an example only and is not printed to scale.

4. You're all set and ready to go!

Once you have successfully tested and printed the first couple of pages, and double-checked the calibration as per steps 3a and 3b, you're all set to go!

1

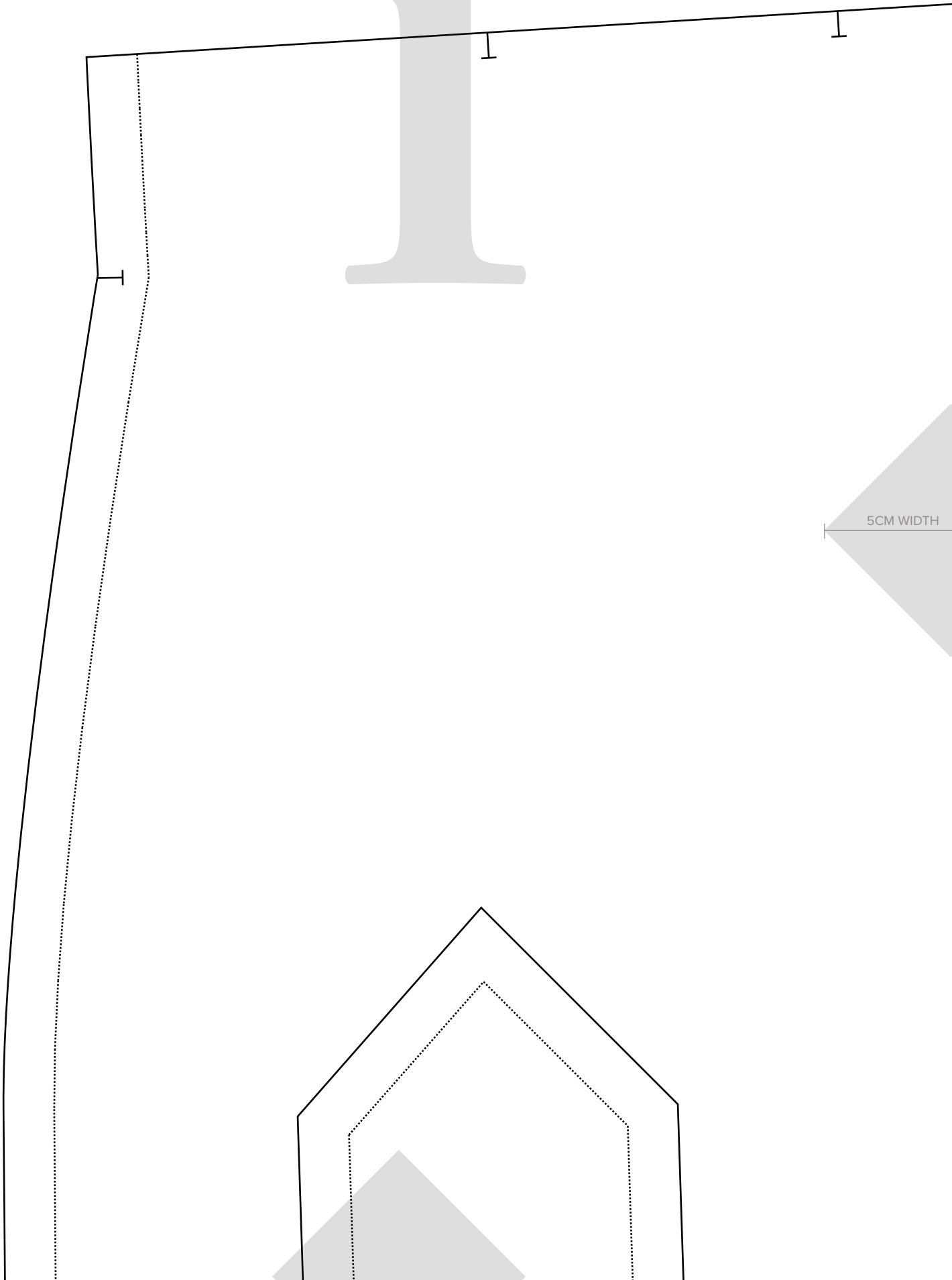

ROSSI & FREDY

SIZE 24
SIDE FRONT #2

Details:
Connect Pattern Piece to front #1
at notches below.

Once connected:
Refer to **SIDE FRONT #1** for cutting instructions
Seam Allowance included: 1cm (3/8")

Grain Line

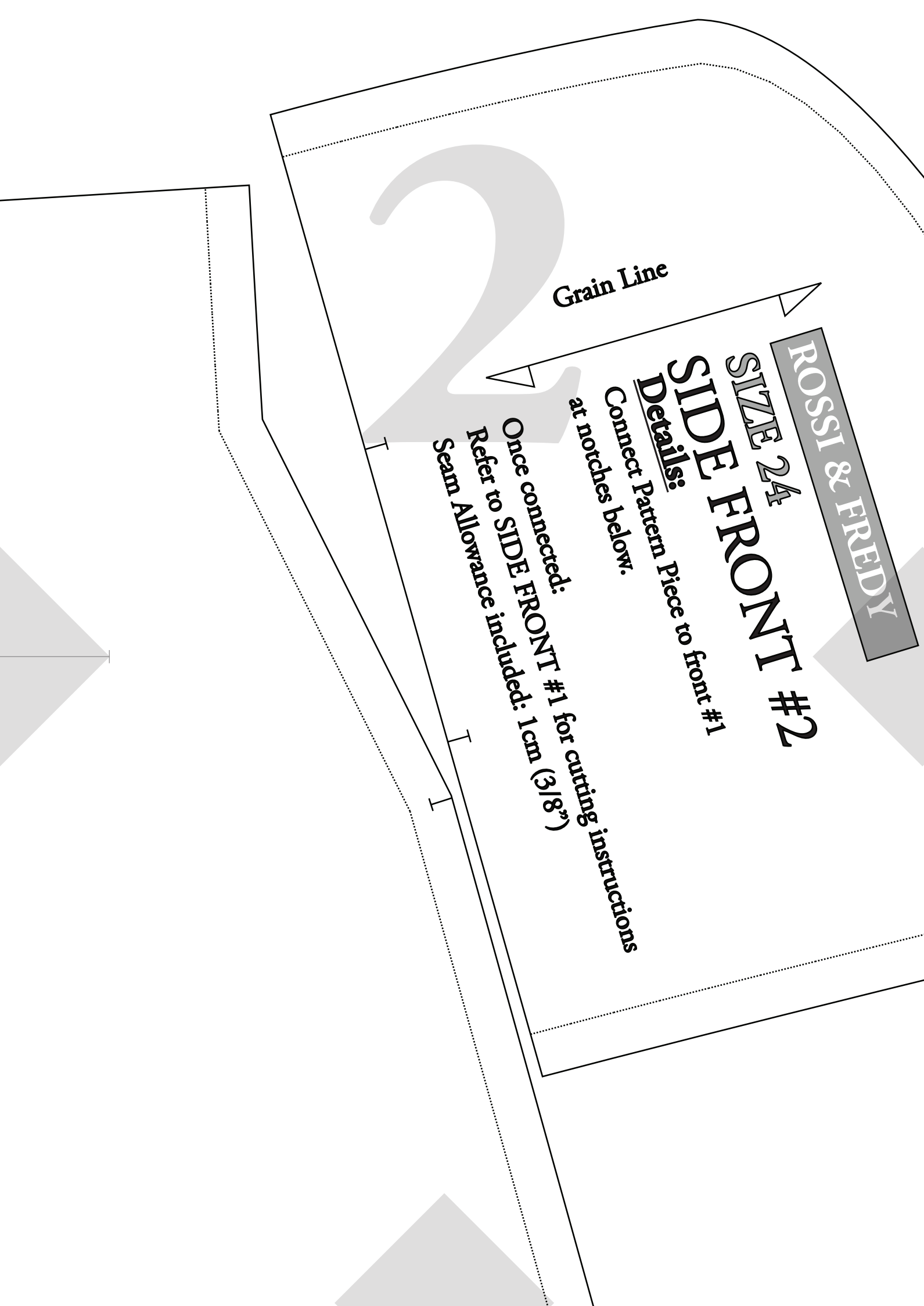

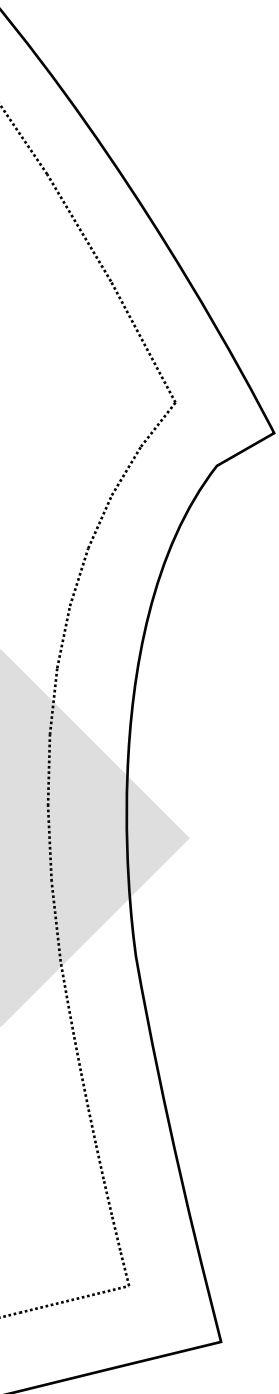

3

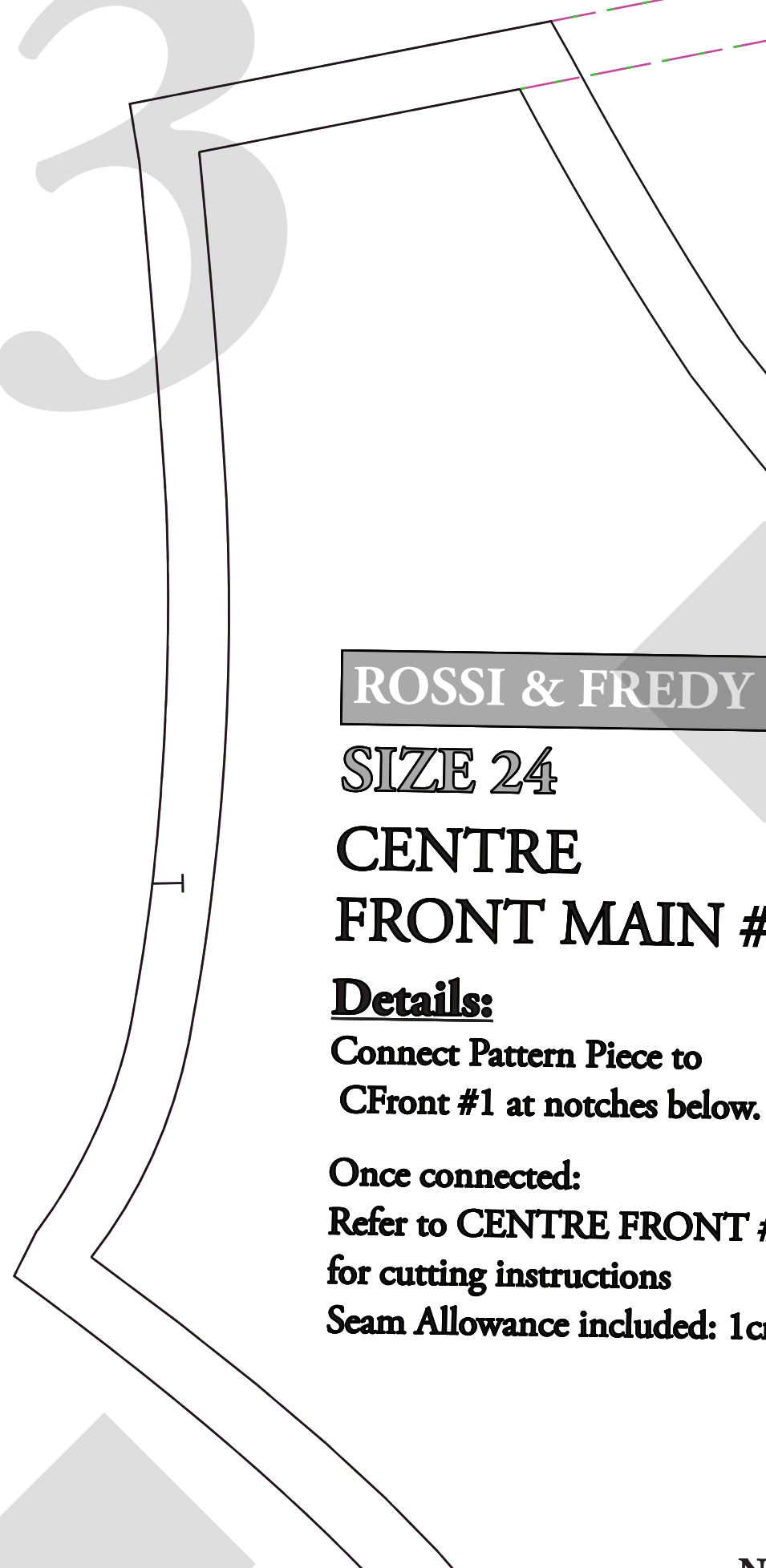

ROSSI & FREDY

SIZE 24

**CENTRE
FRONT MAIN #**

Details:

**Connect Pattern Piece to
CFront #1 at notches below.**

**Once connected:
Refer to CENTRE FRONT #
for cutting instructions
Seam Allowance included: 1cm**

Fredy Wrap + Rossi Wrap – Size 24

© The Bold One Workshop Patterns.
These patterns are copyrighted by
The Bold One Patterns and may not
be copied, shared, or resold.

Reproducing this pattern to sell items
commercially is prohibited.

Seam allowance = 1cm (3/8")

Use the following boxes to check
pattern has been printed to correct scale.

5cm x 5cm

1" x 1"

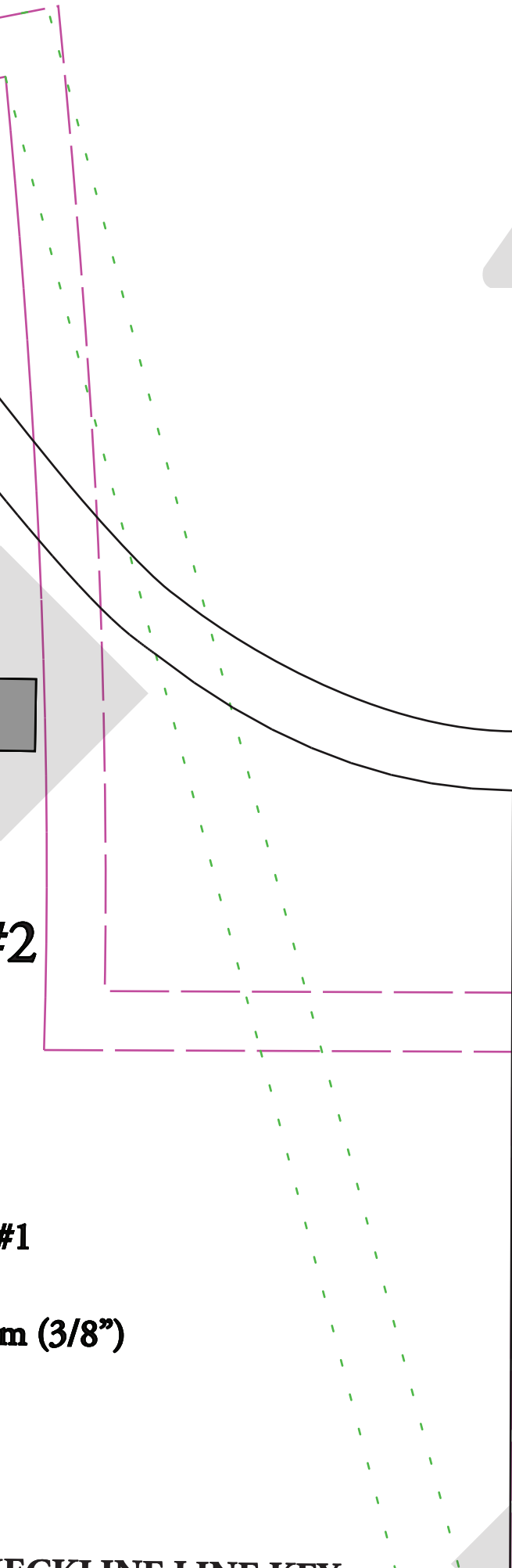

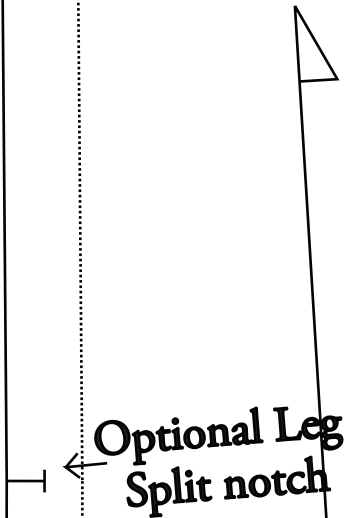

Optional Leg
Split notch

ROSSI & FREDY

DEEP SQUARE NECK SHOULDER TIE

Cut x4

Seam Allowance included: 1cm (3/8")

6

ROSSI & FREDY

SIZE 24

SIDE FRONT #1

Details:

Connect Pattern Piece to #2
at notches at top of pattern piece.

Once connected:

Cut x 1 Pair (2 pieces all up)

Seam Allowance included: 1cm (3/8")

ONT FACING

KLINE LINE KEY:

Neck Front:

Front:

Standard Square Front:

Deep Square Front:

Details:
Cut x1 Pair (x2 pieces in total)
Seam Allowance included:
1cm (3/8")

Fold Line / Grain line

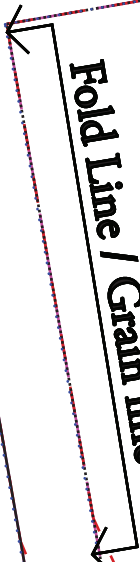

NECKLINE LINE KEY:

Boat Neck Front:

V Front:

Standard Square Front:

Fold Line / Grain line



FRONT
NECK
Boat
V Front
Standard
Detail

Grain Line

Grain Line



The image features a white background with four gray triangles positioned at the corners, pointing towards the center. The top triangle is at the top center, the bottom triangle is at the bottom center, the left triangle is on the left side, and the right triangle is on the right side. In the center of the page, the number '10' is displayed in a large, gray, serif font.

10

11

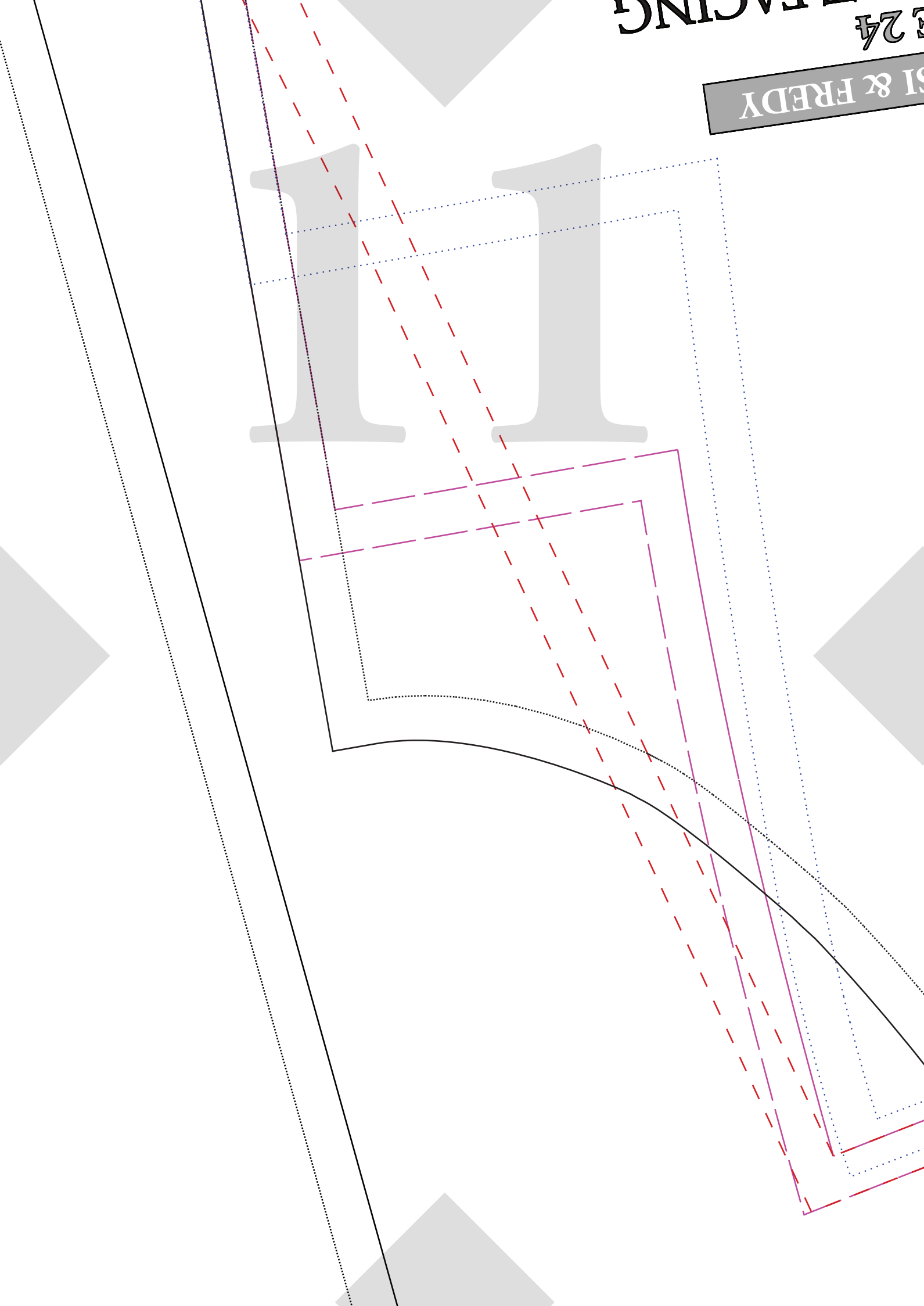

ROSS
SIZES

12

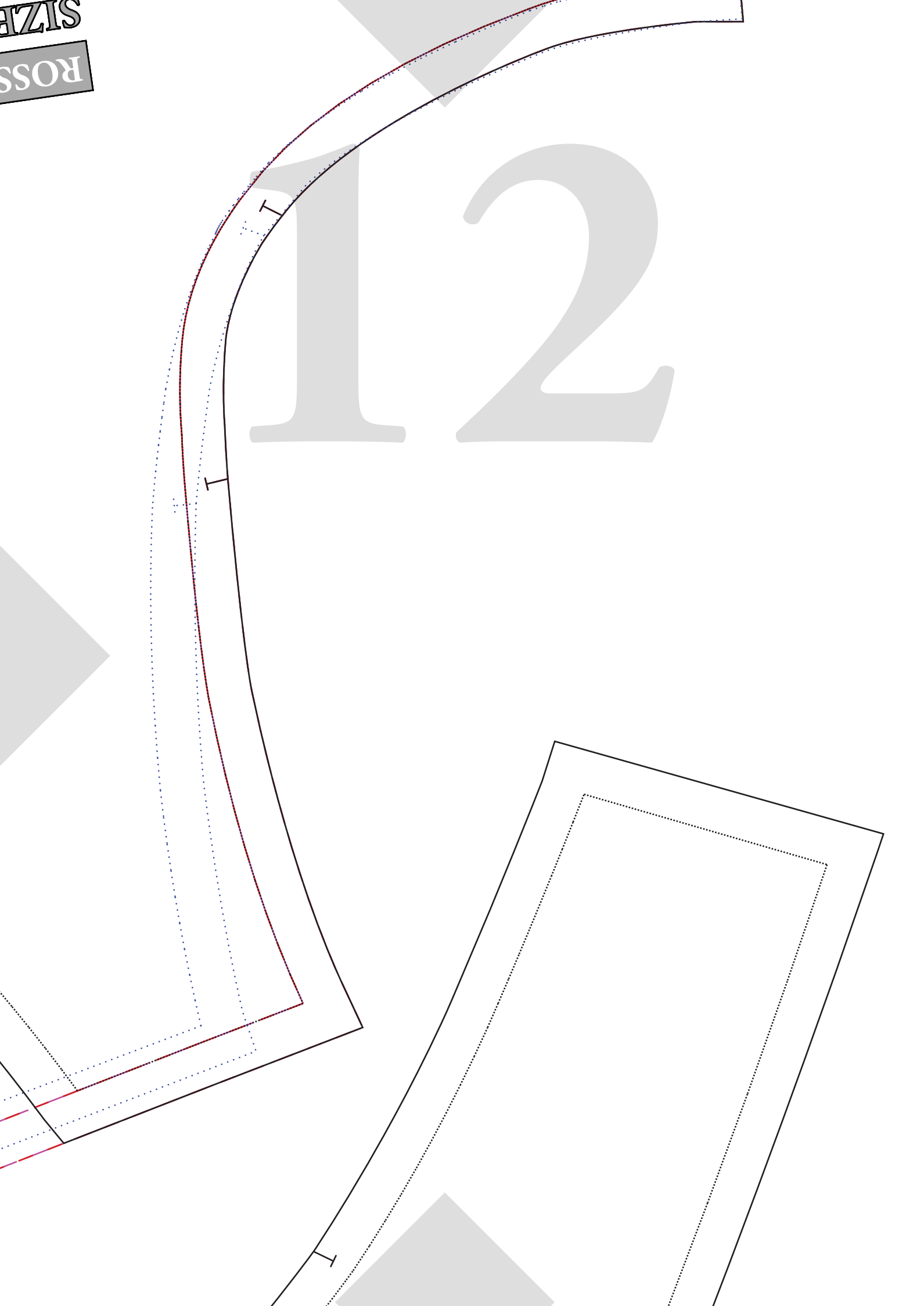

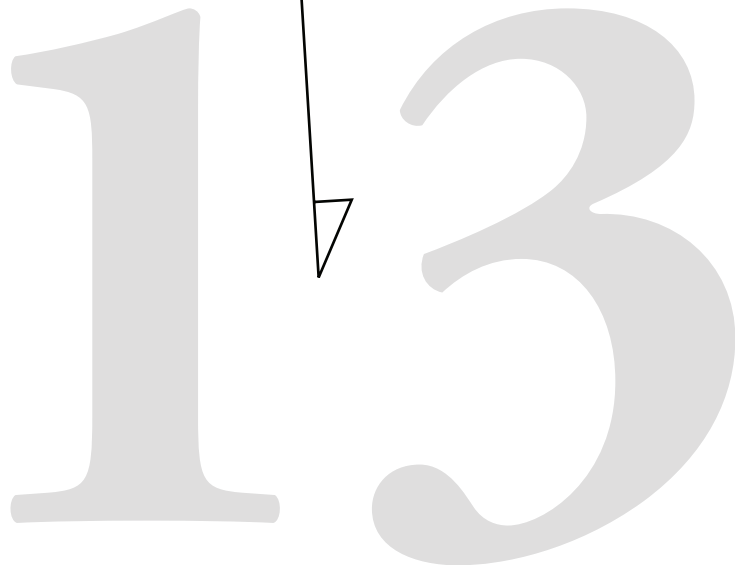

1 3

For Height 150 - 160cm

For Height 161 - 170cm

For Height 171cm+

For Height 171cm+ (Extra Long)

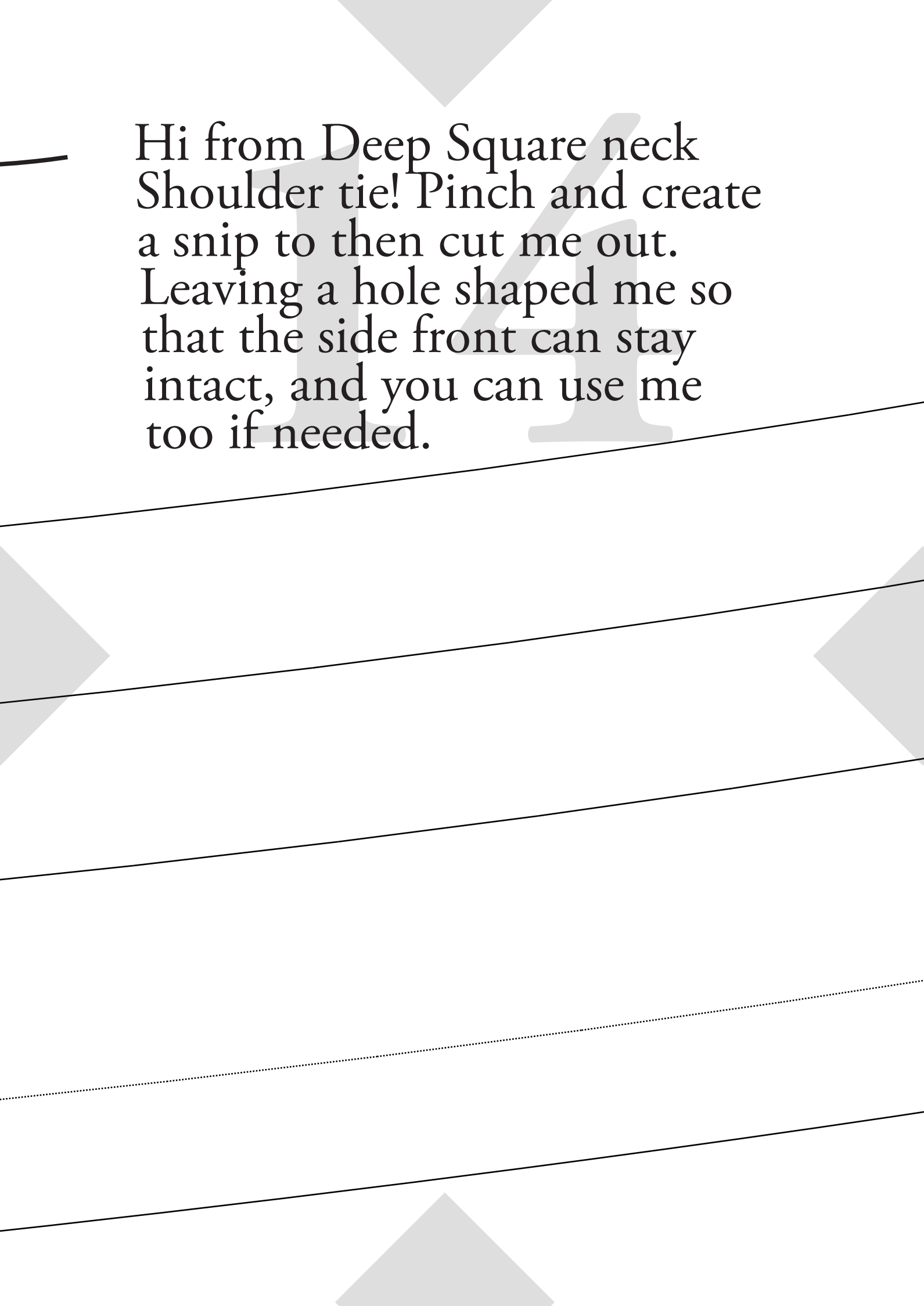

Hi from Deep Square neck
Shoulder tie! Pinch and create
a snip to then cut me out.
Leaving a hole shaped me so
that the side front can stay
intact, and you can use me
too if needed.

15

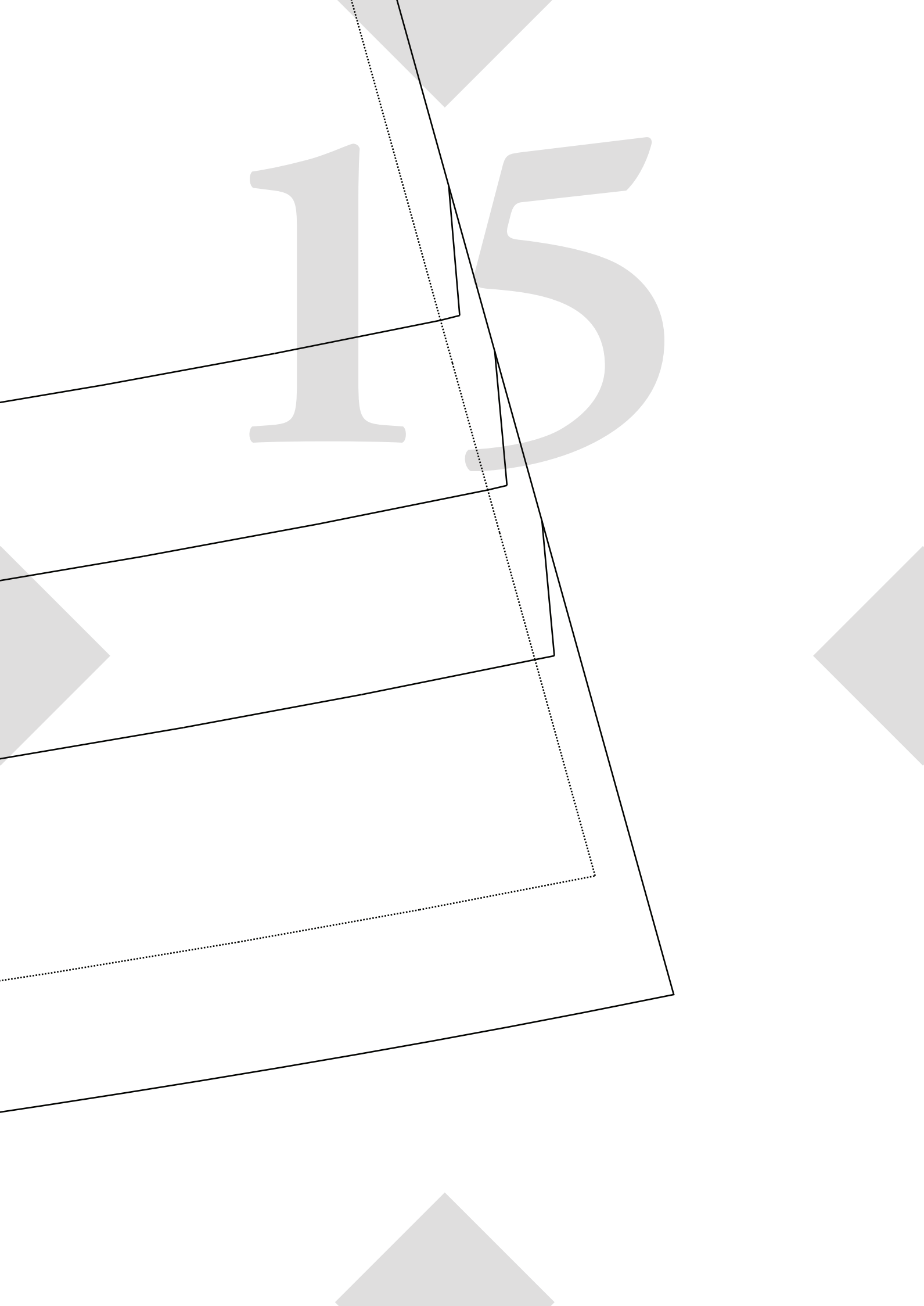

16

ROSSI & FREDY

SIZE 24

CENTRE
FRONT MAIN #2

Deep Square Neckline

Details:

Connect Pattern Piece to
CFront #1 at notches below.

Once connected:
Refer to CENTRE FRONT #1
for cutting instructions
Seam Allowance included:
1cm (3/8")

Fold Line / Grain line

17

ROSSI & FREDY

18

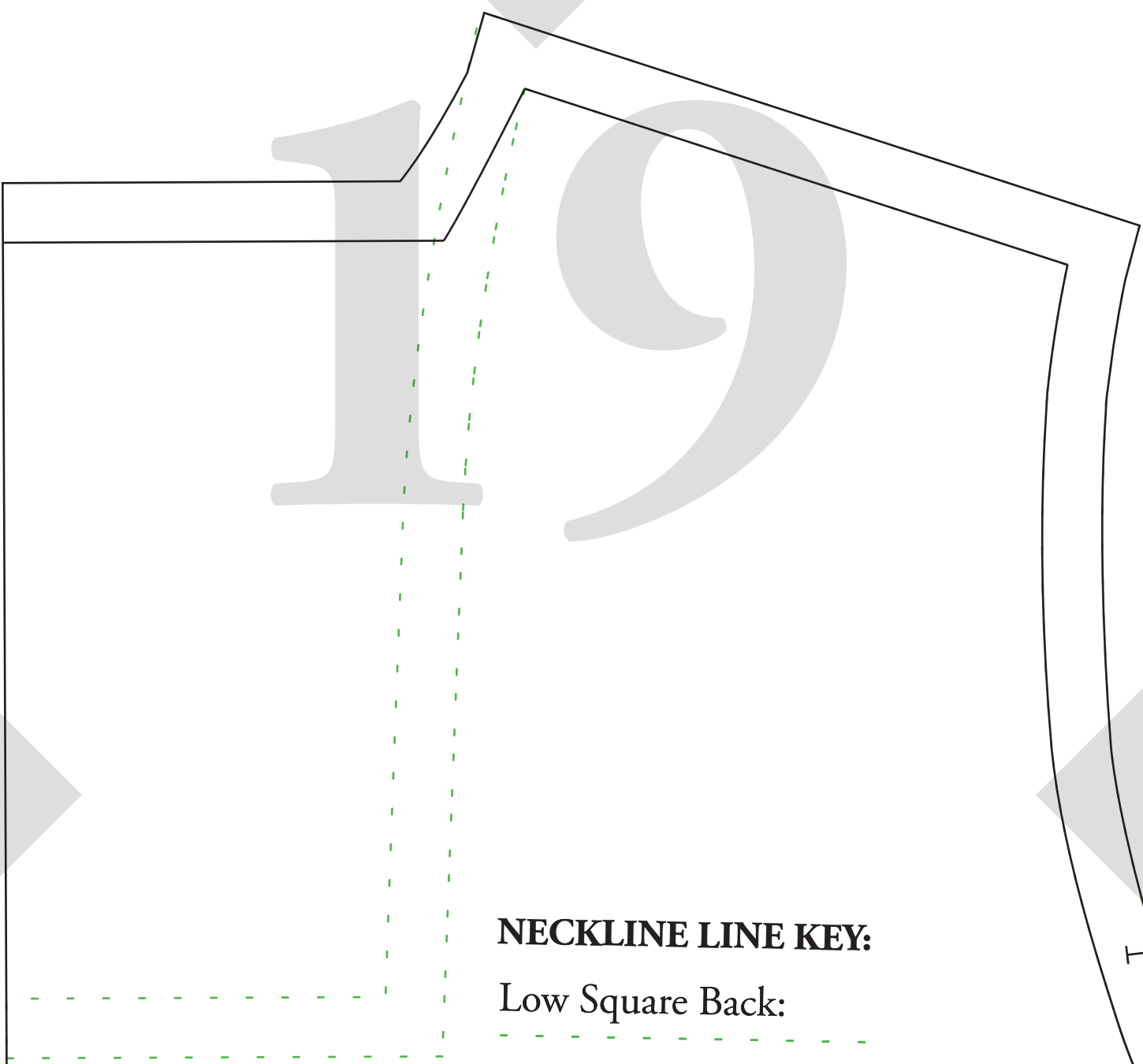

NECKLINE LINE KEY:

Low Square Back:

High Square Back:

ROSSI & FREDY

SIZE 24

CENTRE

BACK MAIN #2

To Match:

Standard Square +

V Neck Front

ROSSI & FREDY

SIZE 24

CENTRE

BACK MAIN #2

Low Square back

To Match:

Deep Square Front

Details:

Connect Pattern Piece to

Back #1 at notches below.

Once connected:

Refer to CENTRE BACK #1

for cutting instructions

Seam Allowance included:

1cm (3/8")

Fold Line / Grain line

TO MATCH DEEP SQUARE BACK BACK BODICE OPTION

SIZE 24

CENTRE FRONT MAIN #1

Details:

Connect Pattern Piece to CF #2
at notches at top of pattern piece

Once connected:

Cut x1 on FOLD

Seam Allowance included: 1cm (3/8")

← Optional Leg
Split notch

SIZE 24

**CENTRE BACK
MAIN #1**

Details:

Connect Pattern Piece to CB #2
at notches at top of pattern piece

Once connected:
Cut x1 on FOLD

Seam Allowance included: 1cm (3/8")

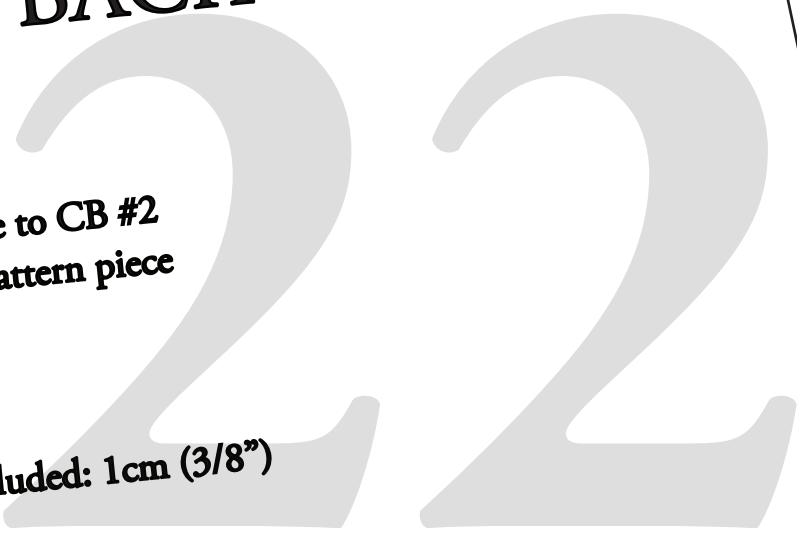

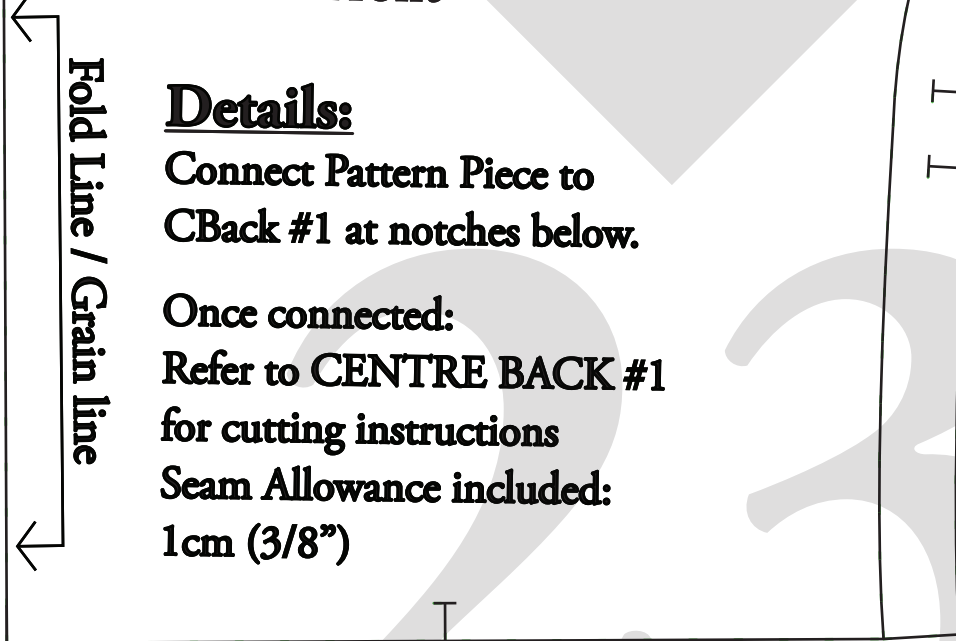

Details:

Connect Pattern Piece to
CBack #1 at notches below.

Once connected:
Refer to CENTRE BACK #1
for cutting instructions

Seam Allowance included:
1cm (3/8")

**^ TO MATCH STANDARD
SQUARE & V NECK FRONT
BACK BODICE OPTIONS**

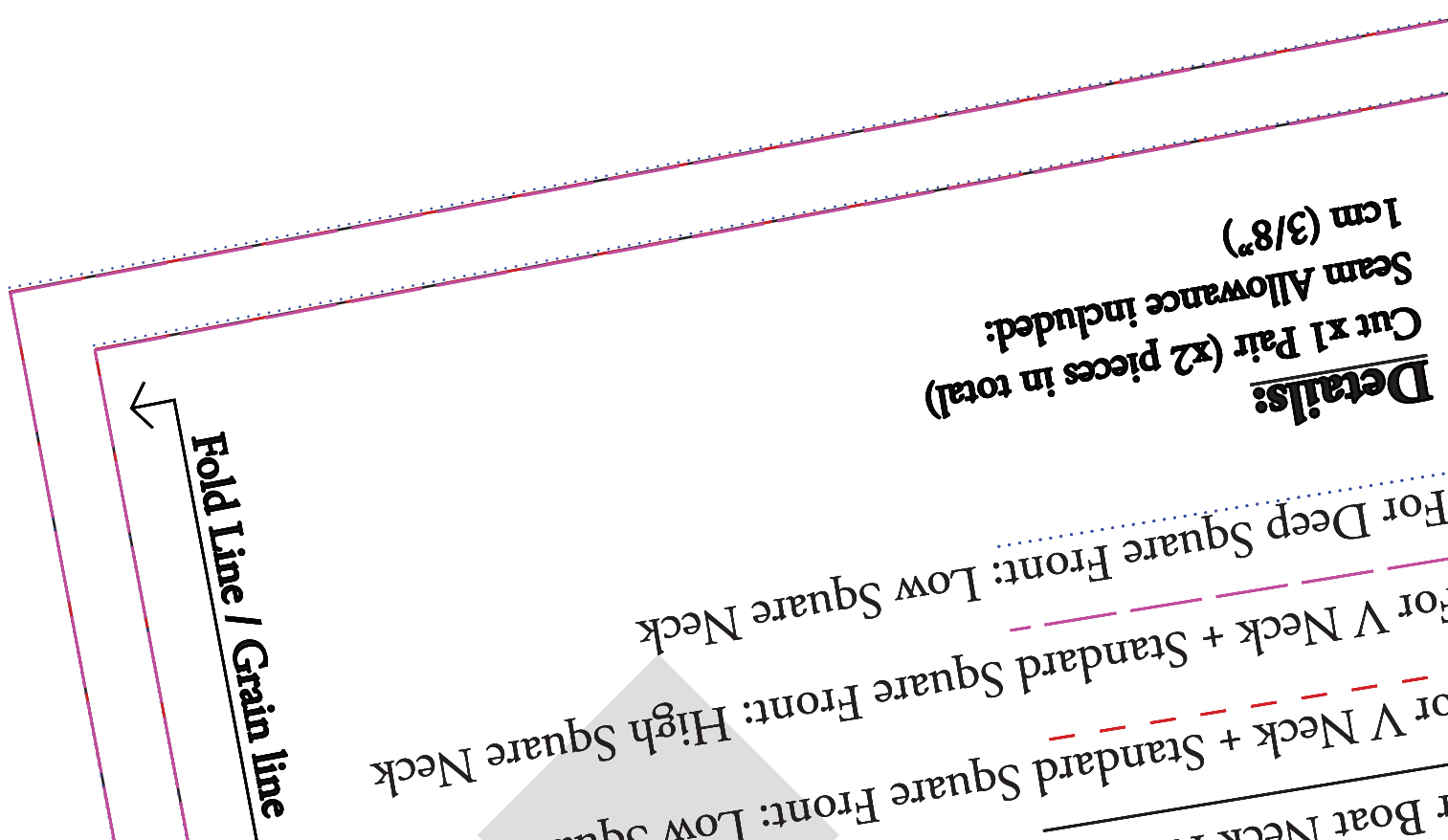

Details:
Cut x1 Pair (x2 pieces in total)
Seam Allowance included:
1cm (3/8")

Fold Line / Grain line

For V Neck + Standard Square Front: Low Square Neck
 For V Neck + Standard Square Front: High Square Neck
 For Deep Square Front: Low Square Neck

24

I

For
Fo
H

25

Fold Line / Grain line



26

Fold Line / Grain line

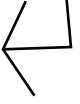

CKLINE LINE KEY:

Neck Front: Low Square Neck

Neck Back: Square Neck

BACK FACING
E 24

SI & FREDY

27

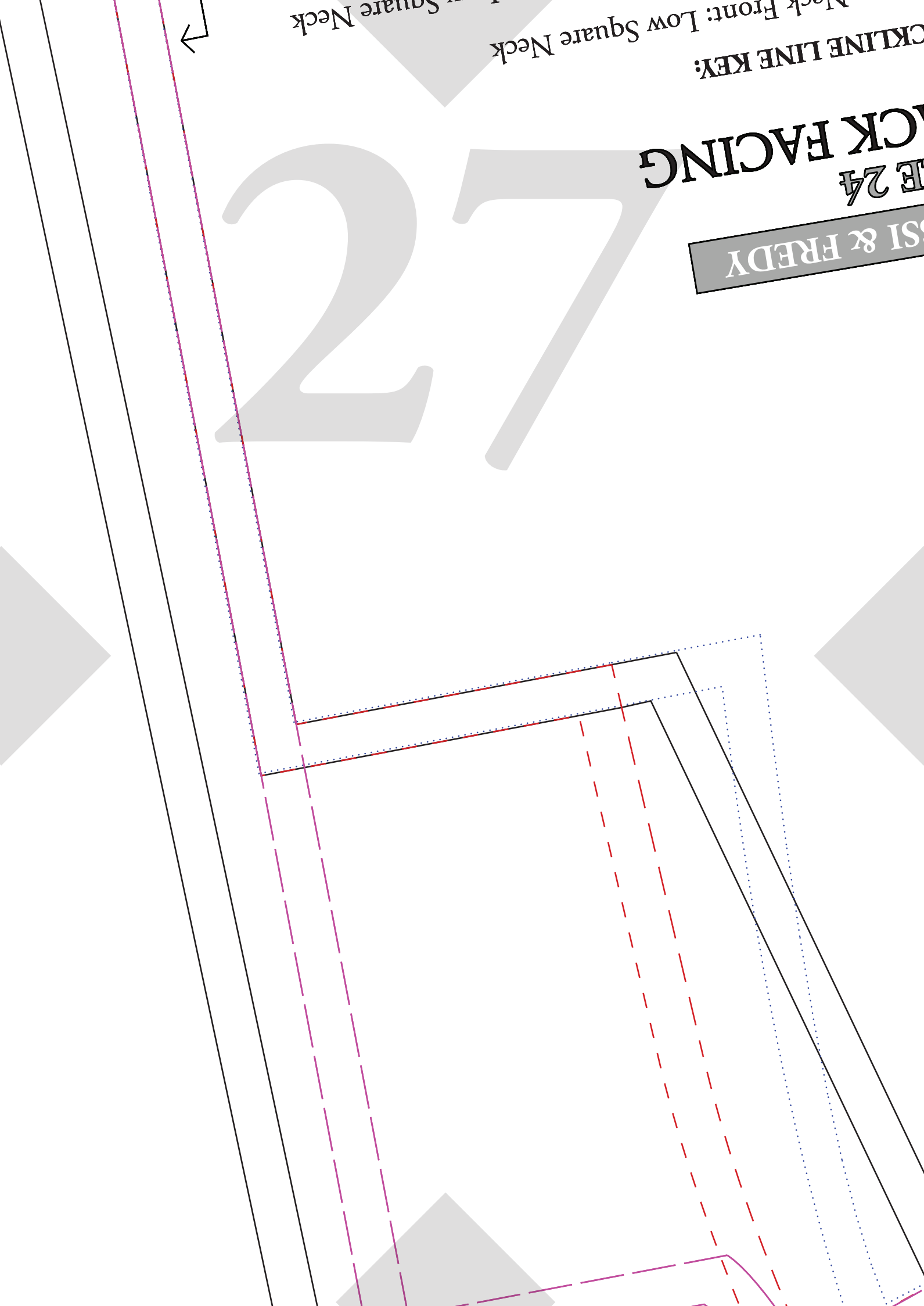

NEC
BA
SIZ
ROS

28

∇ TO MATCH BOAT NECK FRONT BACK BODICE OPTION



BACK MAIN #2

Low Square back

To Match:

Boat Neck Front

Details:

Connect Pattern Piece to

CBack #1 at notches below.

Once connected:

Refer to CENTRE BACK #1

for cutting instructions

Seam Allowance included:

1cm (3/8")

Fold Line / Grain line



29

For Height 150

For Height 160

For Height 170

For Height 171cm

30

- 160cm

For Height 150 - 160cm

1 - 170cm

For Height 161 - 170cm

ght 171cm +

For Height 171cm+

+ (Extra Long)

For Height 171cm+ (Extra Long)

31

ROSSI & FREDY
CENTRE
SIZE 24

ROSSI & FREDY

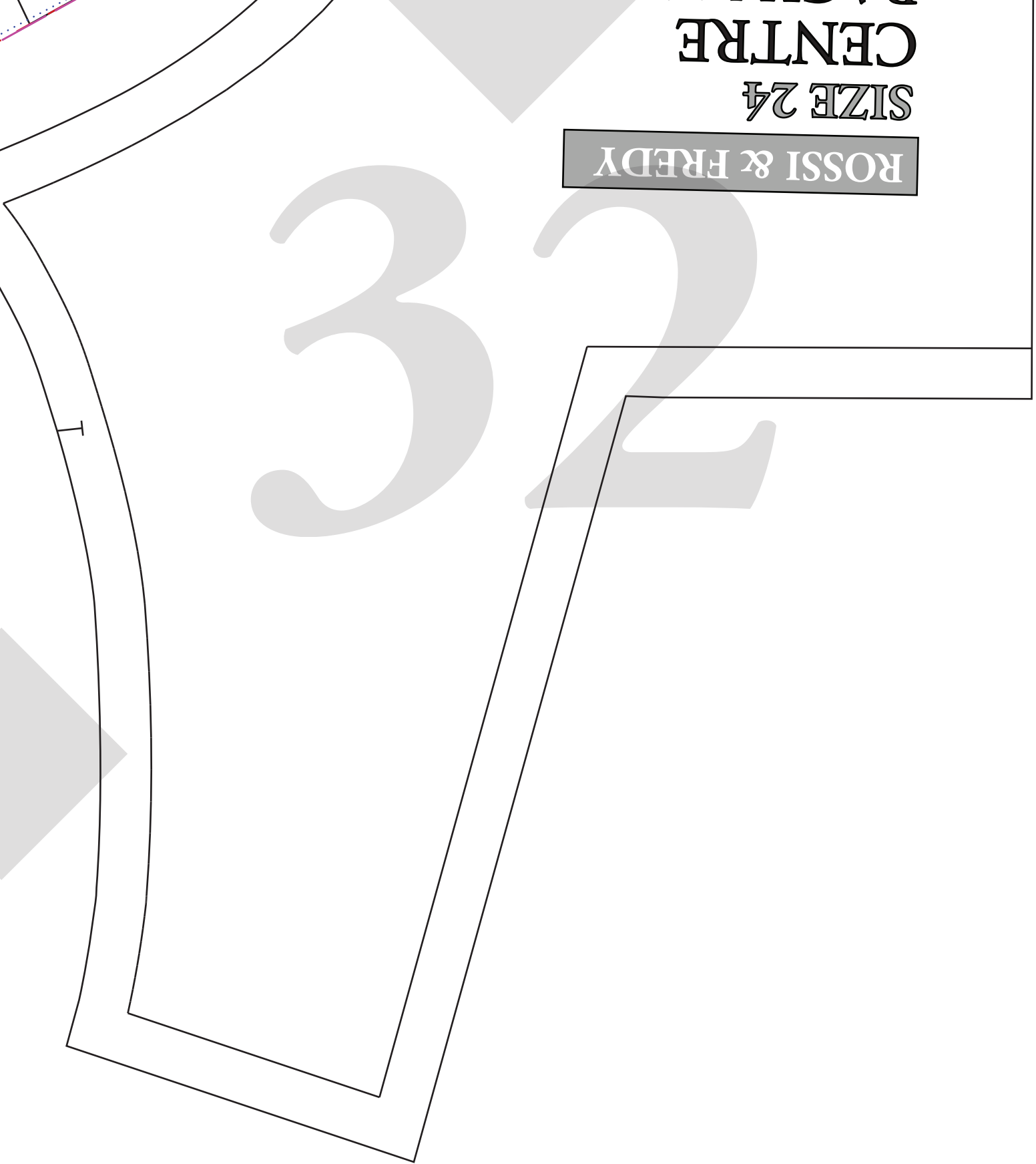

33

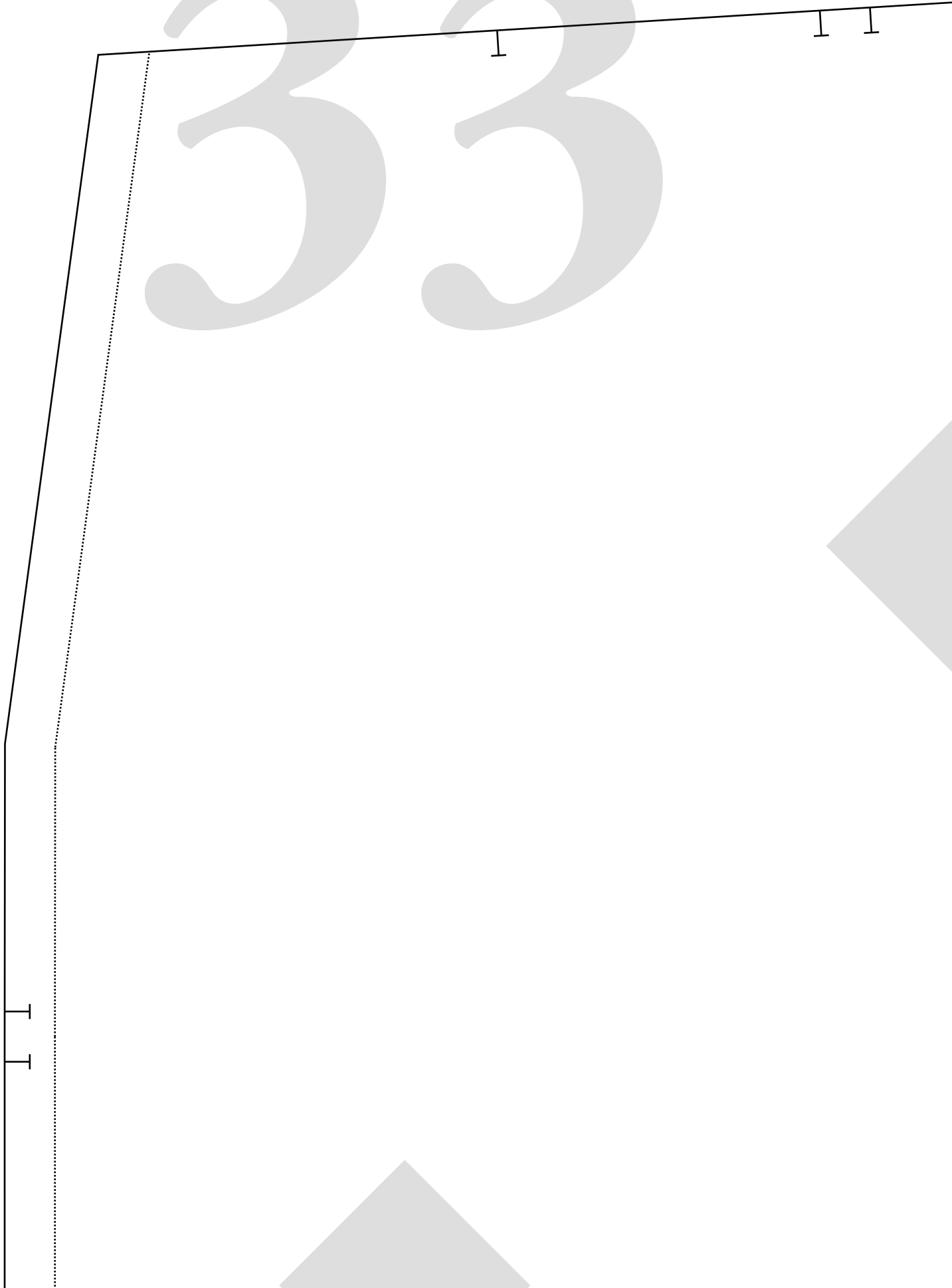

34

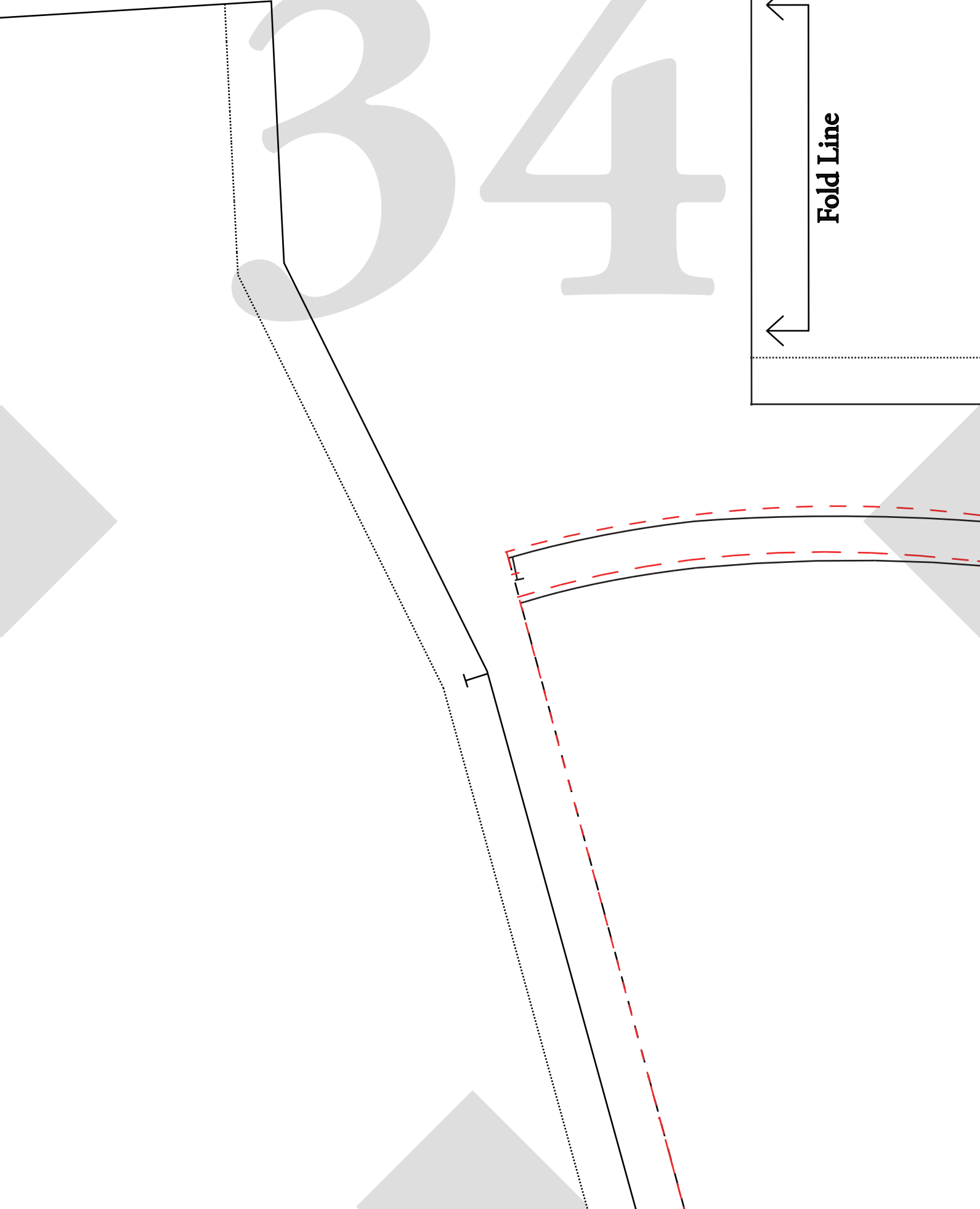
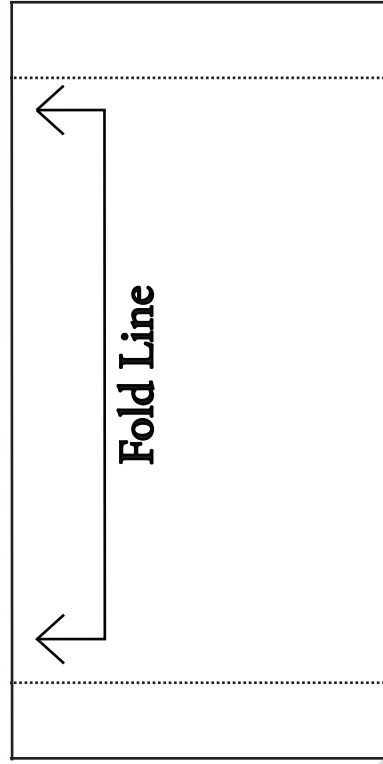

ROSSI & FREDY

SIZE 24

SHORT PUFF
SLEEVE CUFF

Details:

Cut x2 on Fold

(Measure upper arm to compare)

Seam Allowance included: 1cm (3/8")

Grain Line

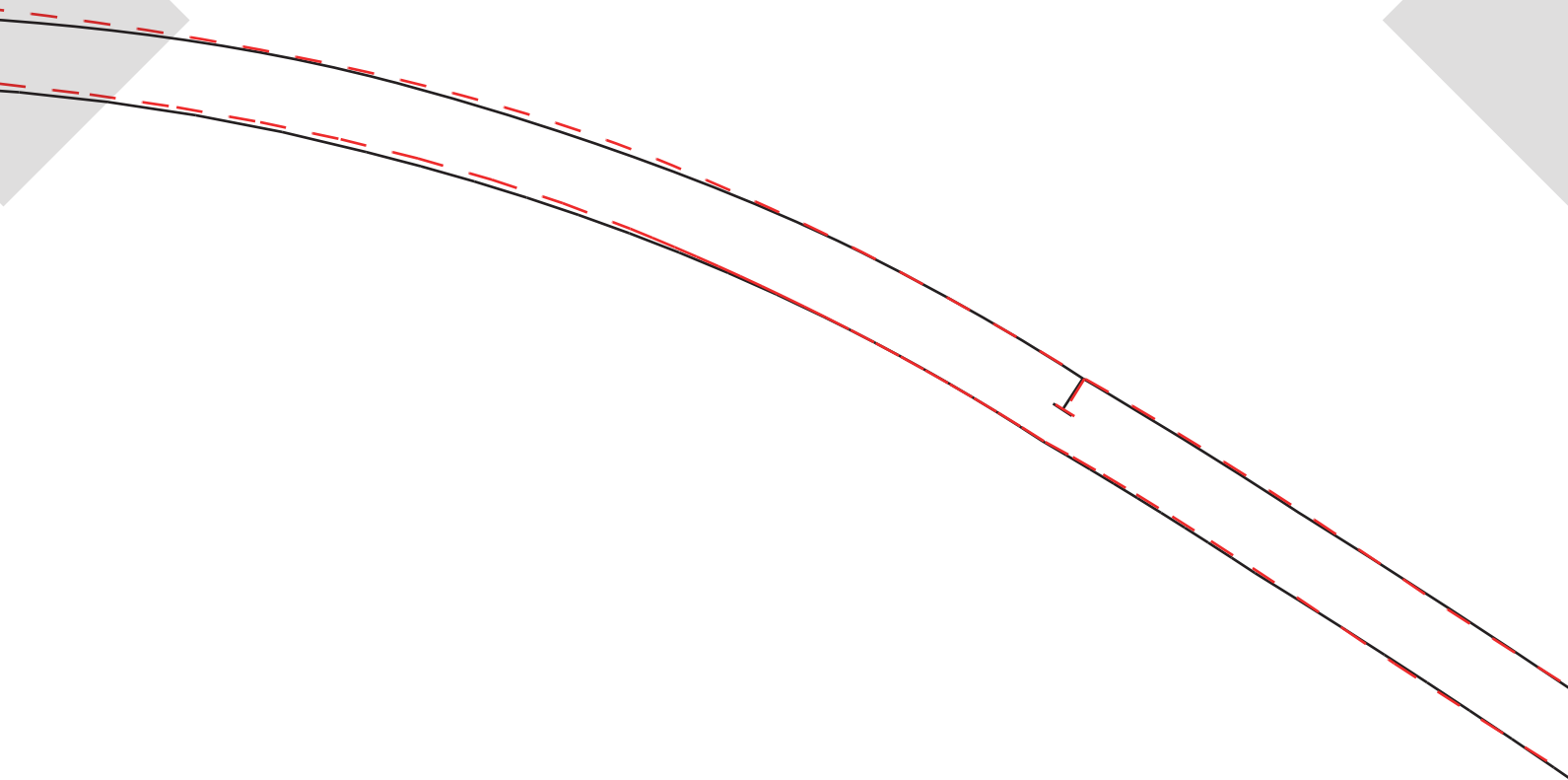

ROSSI & FREDY

POCKET BAG

Details:

Cut x 4

Seam Allowance: 1cm (3/8")

Grain Line

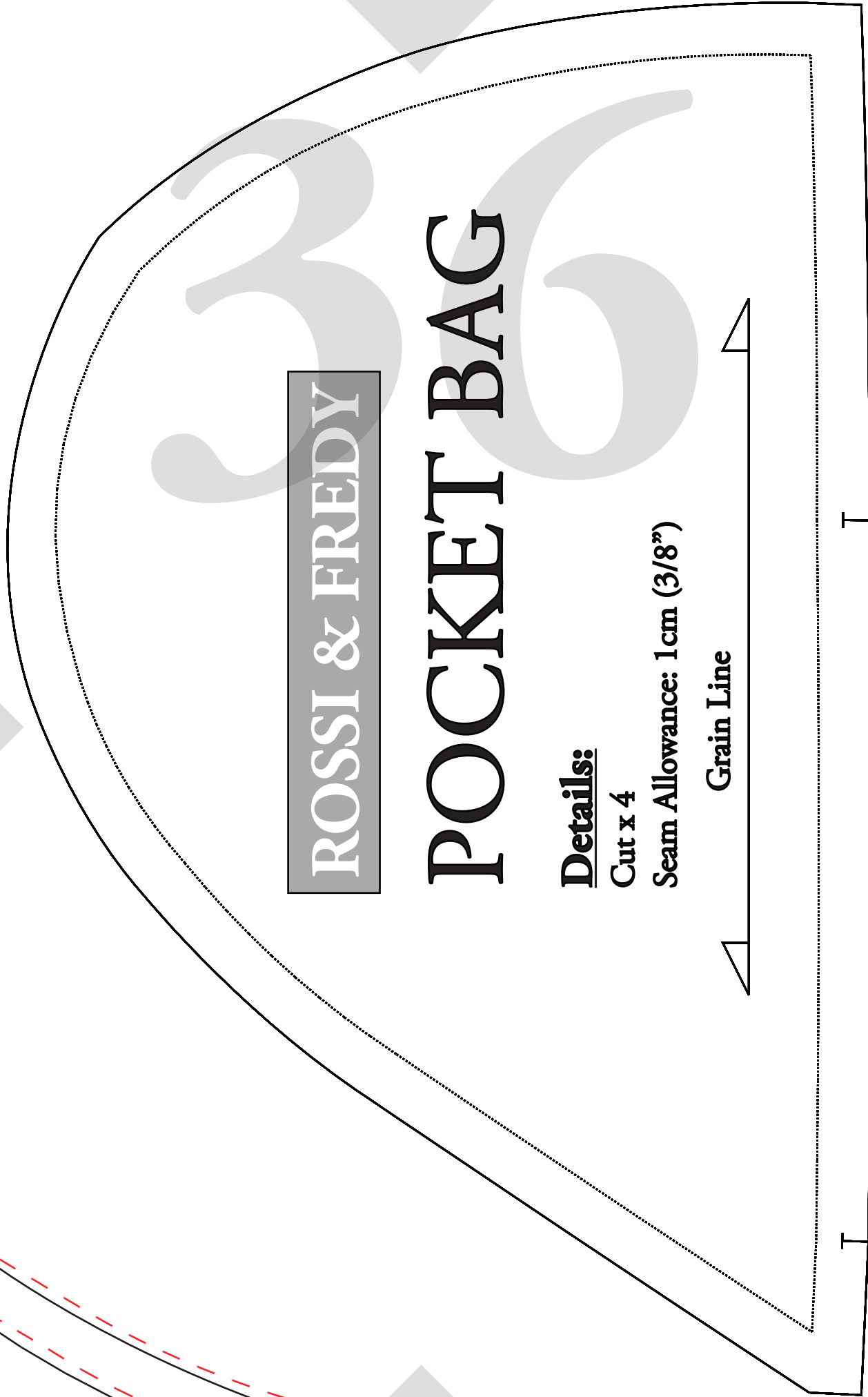

ROSSI & FREDY

SIZE 24

SIDE BACK #1

Details:

Connect Pattern Piece to #2
at notches at top of pattern piece

Once connected:

Cut x 1 Pair (2 pieces all up)

Seam Allowance included: 1cm (3/8")



ie

FREDDY

CHIE

ed: 1 cm (3/8")

Fold Line

Grain Line

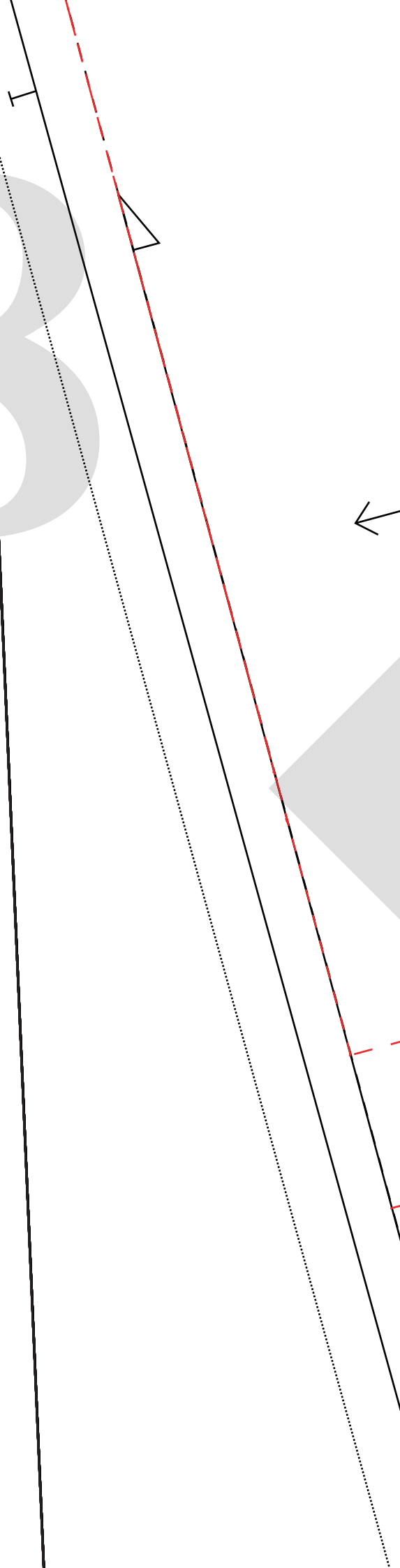
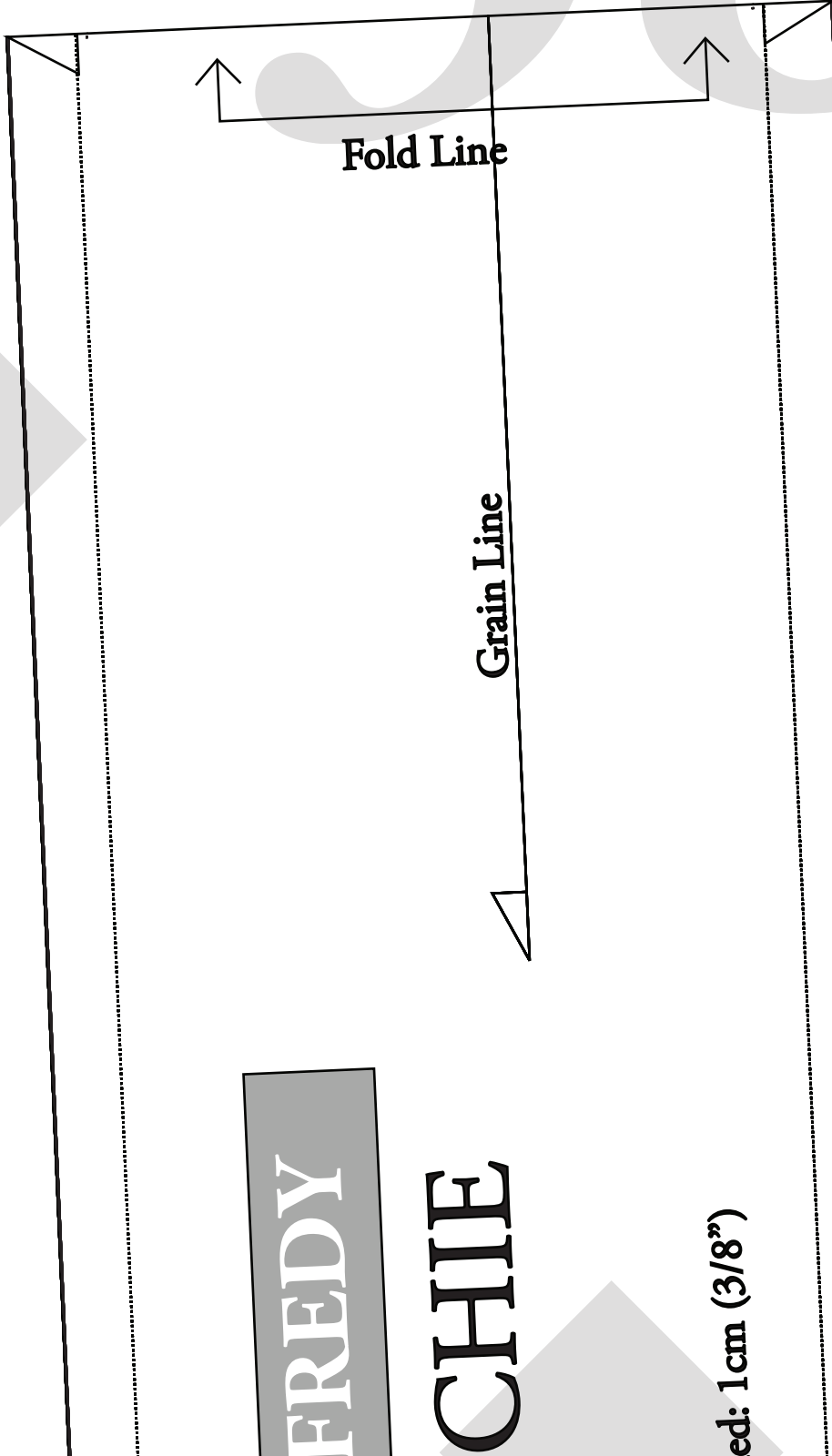

Grain Line / Fold Line

ROSSI & FREDY

SIZE 24

SHORT PUFF SLEEVE

Details:
Cut x 2 on fold

Seam Allowance included: 1 cm (3/8")

LINE KEY

SHORT PUFF SLEEVE:

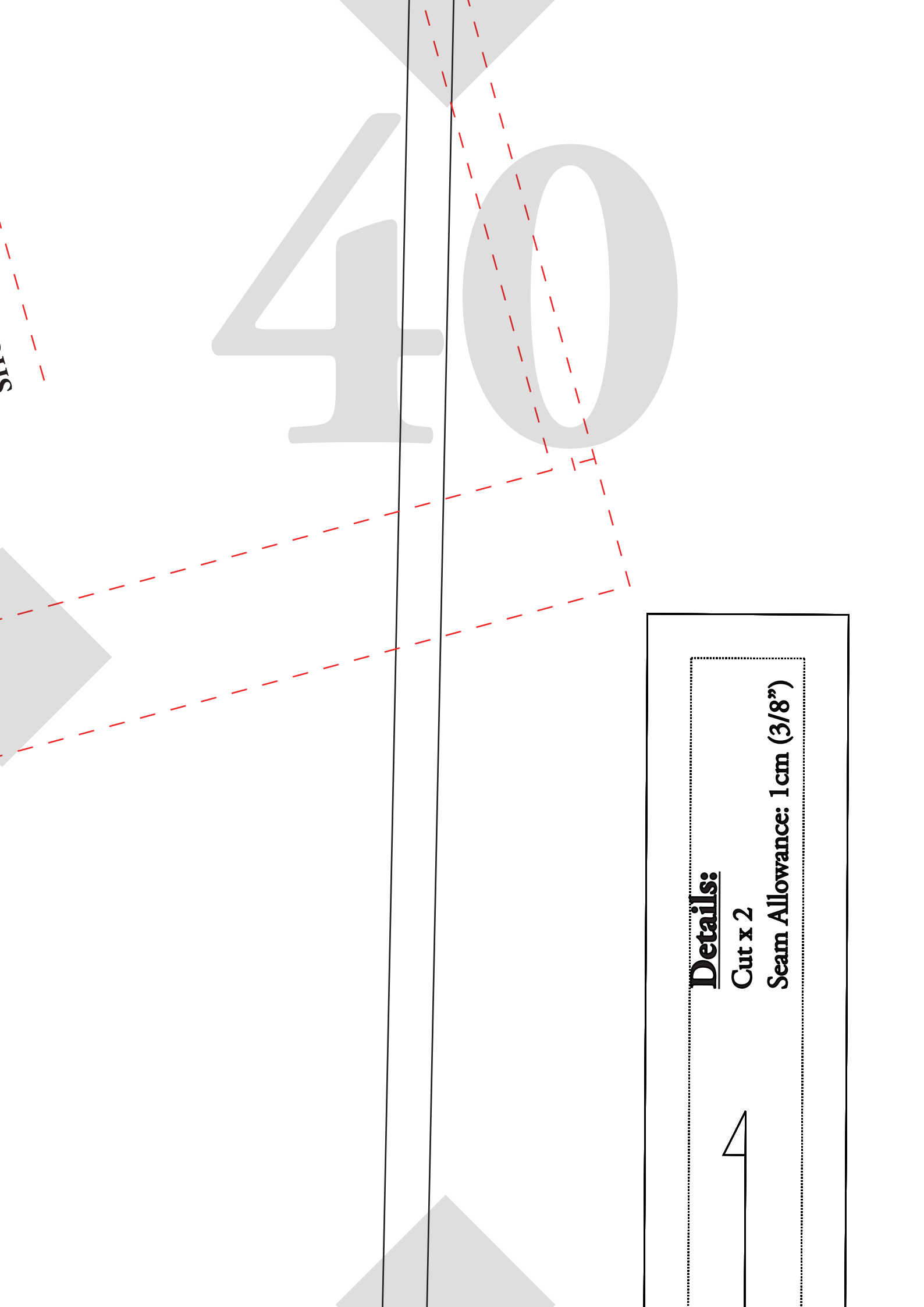

Details:

Cut x 2

Seam Allowance: 1 cm (3/8")



41

Grain Lin



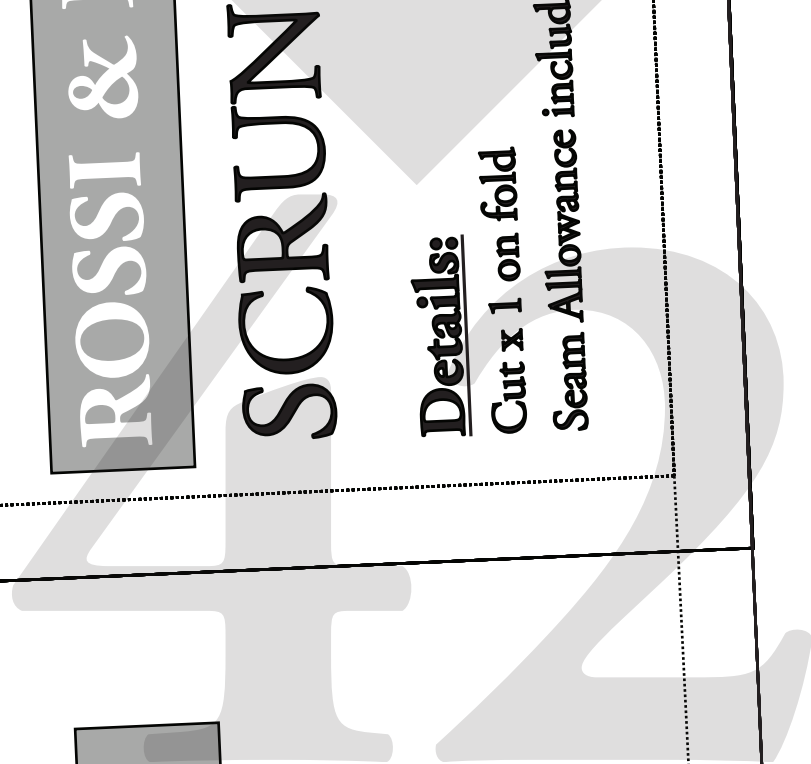

ROSSI & FREDY
HEAD SCARF

Details:

Cut x 1 on fold. Include scrunchie section
Seam Allowance included: 1 cm (3/8")

ROSSI &

SCRUNCHIE

Details:

Cut x 1 on fold
Seam Allowance included



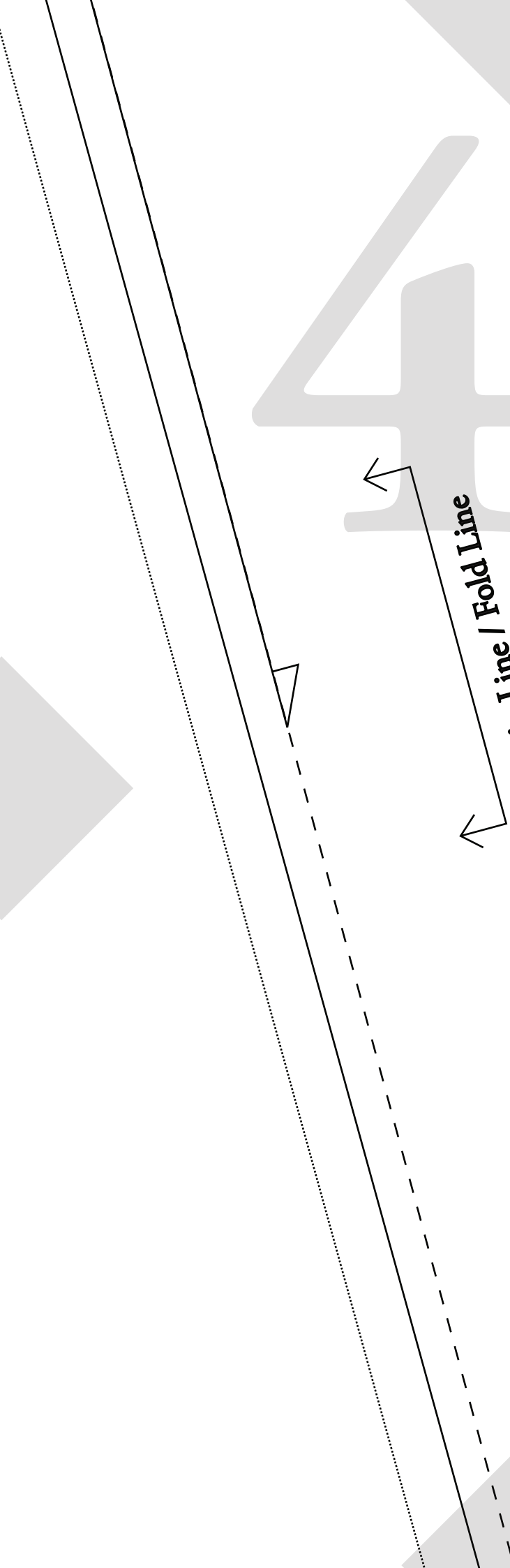

Grain Line / Fold Line

ROSSI & FREDY

SIZE 24

**LONG SHIRRED
SLEEVE**

Details:
Cut x 2 on fold
Seam Allowance included: 1cm (3/8")

LINE KEY

LONG SHIRRED:

ROSSI & FREDY

BACK NECK TIE



45

For Height 150 - 160cm

For Height 161 - 170cm

For Height 171cm+

For Height 171cm+ (Extra Long)

Hi from Scrunchie & Head scarf! Pinch and create a snip to then cut me out. Leaving a hole shaped me so that the side front can stay intact, and you can use me too if needed.



4 7

SU

Seam Allowance included: 1cm (3/8")
Refer to SIDE BACK #1 for cutting instructions

Once connected:
Connect Pattern Piece to Back #1
at notches below.

Details:
SIZE 24
SIDE BACK #2

Grain Line

ROSSI & FREDY

Thin / Standard Waist
Wrap Add on

SIZE 16 - 30

Grain Line



Details:

Cut x 2 Pairs (all up x4 pieces)

Seam Allowance Included: 1cm (3/8")



49



A large rectangular area with a solid black border on the left and top, and a dotted line on the right and bottom. A vertical dashed line is positioned on the right side of the dotted line, extending from the top to the bottom of the dotted line.

550

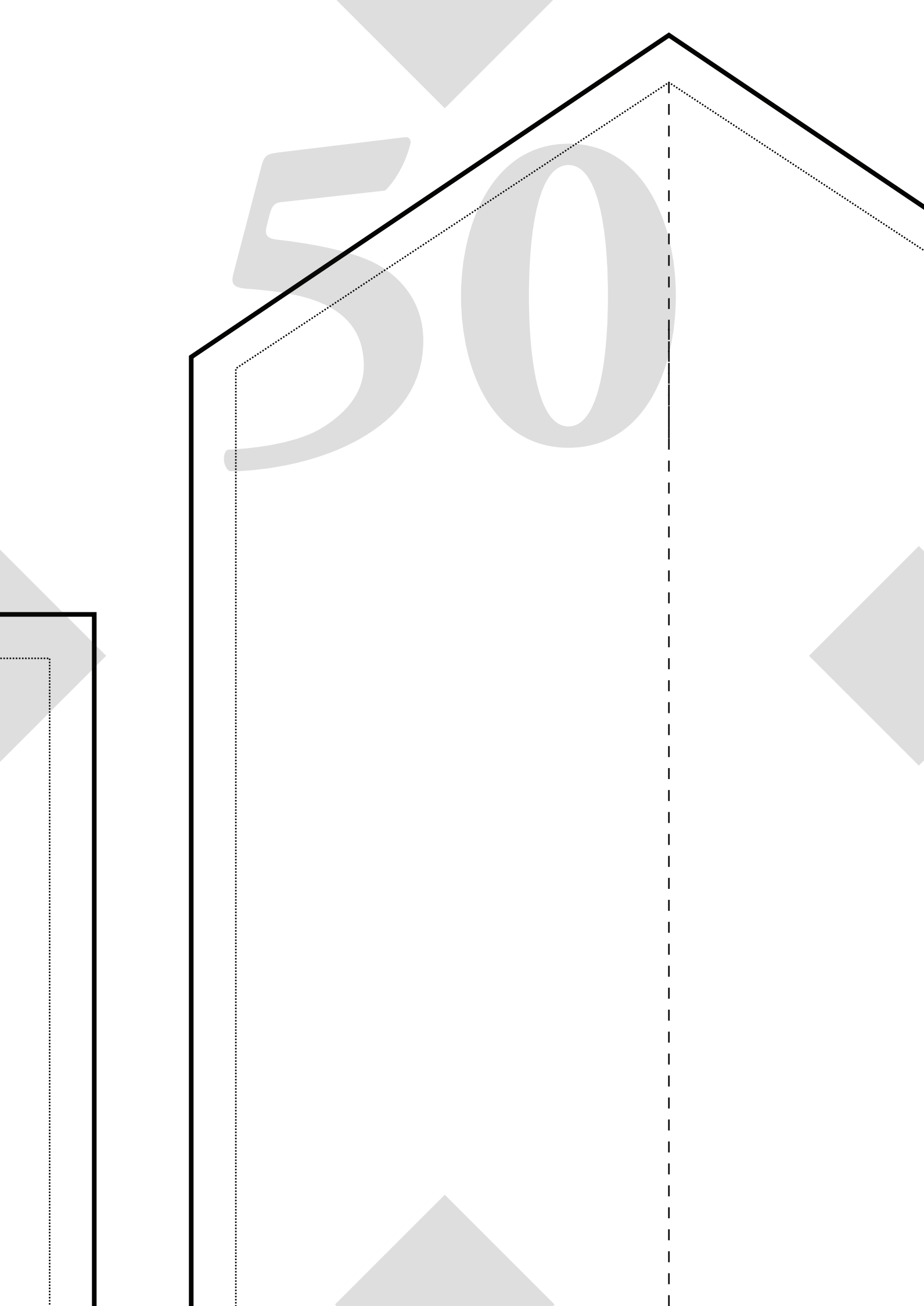

51

ROSSI & FREDY

SIZE 22-30

TWO TONE WAIST WRAP #1

Details:

Connect Pattern Piece to #2

Once Connected :

Cut x 2 in Primary Colour (one pair)

Cut x 2 in Secondary Colour (one pair)

Seam Allowance included: 1cm (3/8")



Grain Line / Fold Line



53



Grain Line / Fold Line

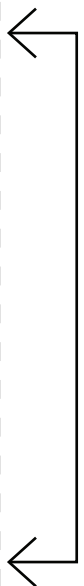

54

55

Grain Line



56

ROSSI & FREDY

SIZE 16 – 30

THIN WAIST WRAP #1

Details:

Connect Pattern Piece to #2

Once connected:

Cut x 2

Seam Allowance included: 1cm (3/8")

Join Connecting Piece Here



ROSSI & FREDY

SIZE 16 – 30

THIN WAIST WRAP #2

Details:

Connect Pattern Piece to #1

See Wrap #1 once connected for cutting instruction

Seam Allowance included: 1cm (3/8")

Join Connecting Piece Here



ROSSI & FREDY

SIZE 22 - 30

TWO TONE WAIST WRAP #2

Details:

Connect Pattern Piece to #1
See Wrap #1 once connected
for cutting instructions
Seam Allowance included: 1cm (3/8")

Join Connecting Piece Here

60

