

test square

10X10cm

Kristy cowl neck dress pattern

Size XS/S/M/L

All panels include 1cm seam allowance

Measurements	XS size	S size	M size	L size	XL size
Bust	82-86cm	88-92cm	94-98cm	100-104cm	106-110cm
Waist	62-66cm	68-72cm	74-76cm	78-82cm	84-88cm
Hips	86-90cm	92-96cm	98-102m	104-108cm	110-114cm
Garment length	114cm	114cm	114cm	114cm	114cm

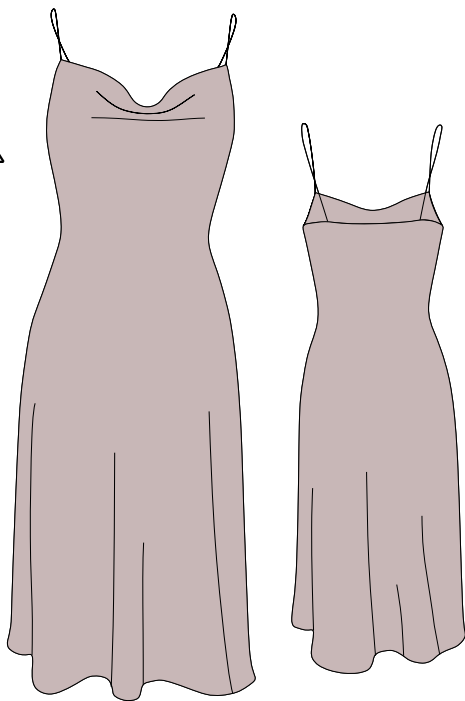

————— XSmall
- - - - - Small
- - - - - Medium
..... Large
- - - - - XLarge

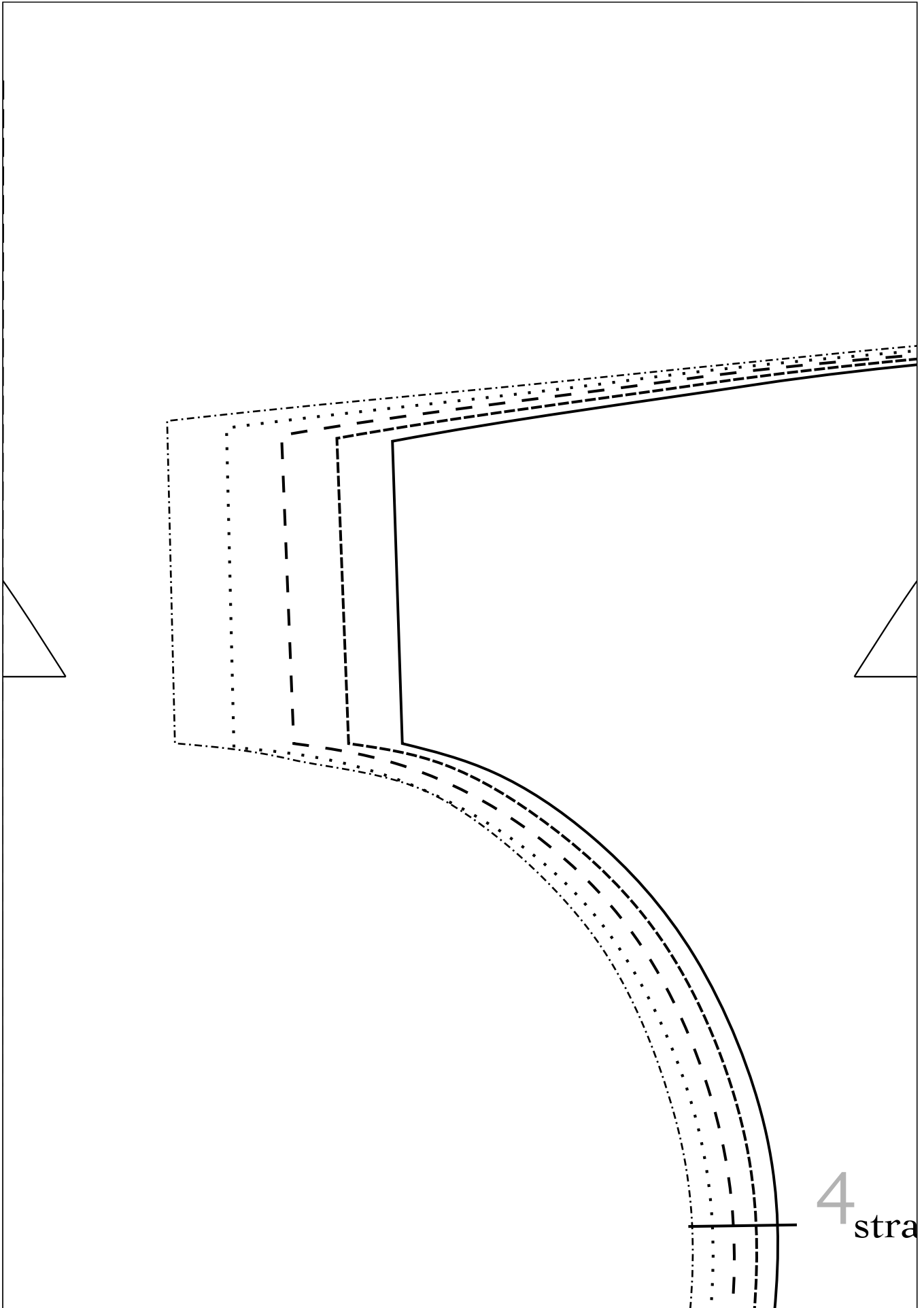

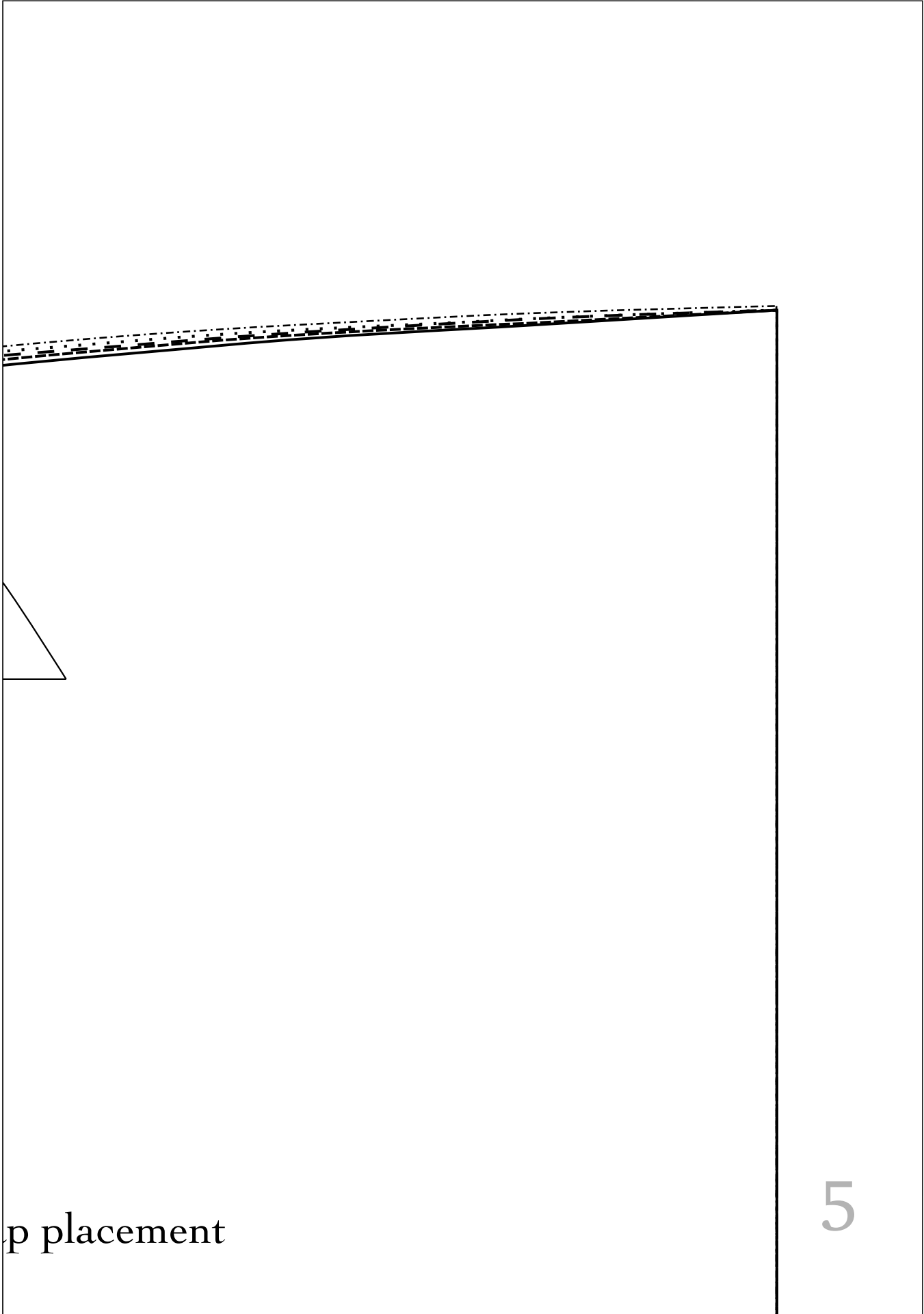

p placement



strap placement

Kristy cowl neck dress

back panel

1det with fold

6.

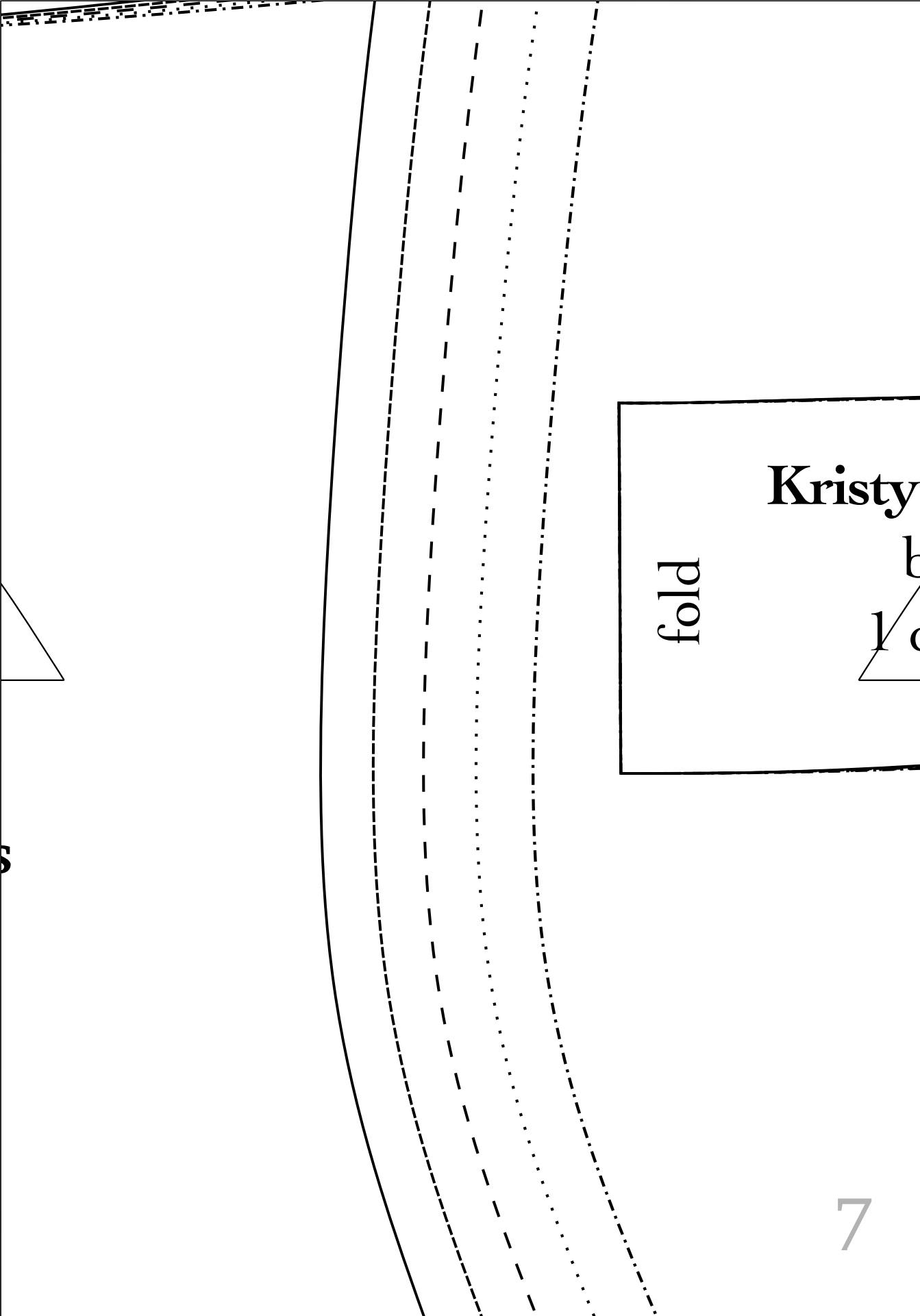

5

Kristy
 b
 1 c

fold

cowl neck dress

back facing

det with fold

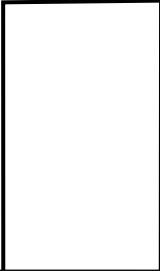
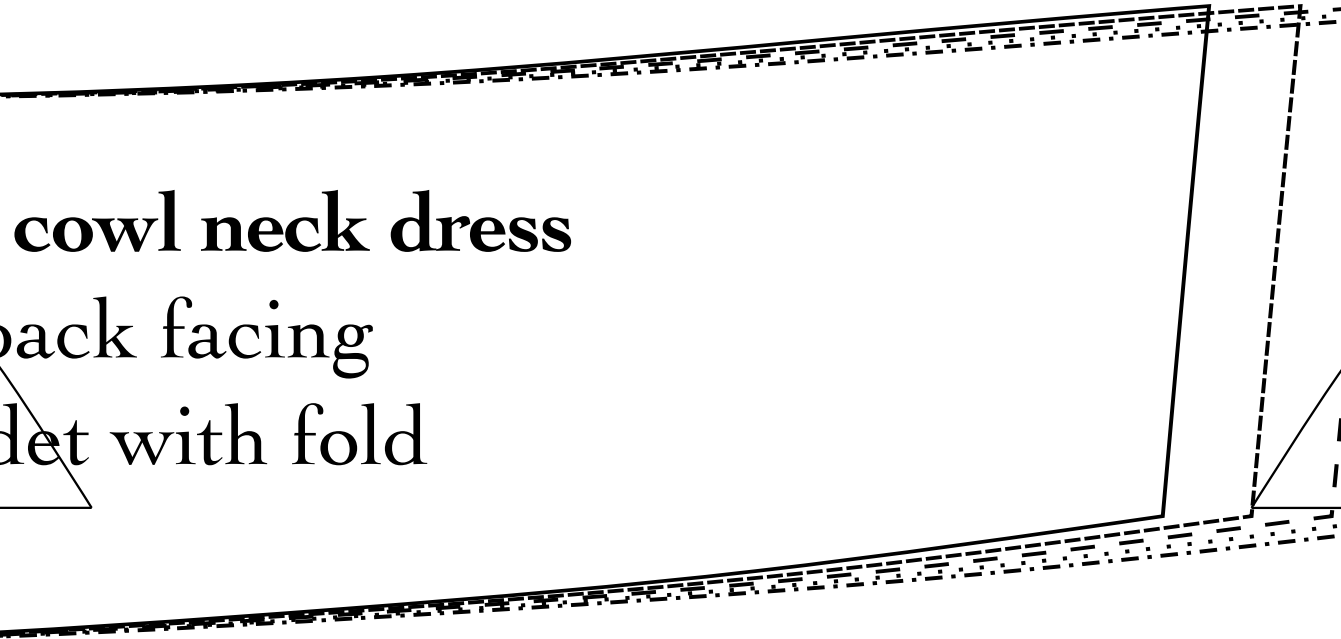

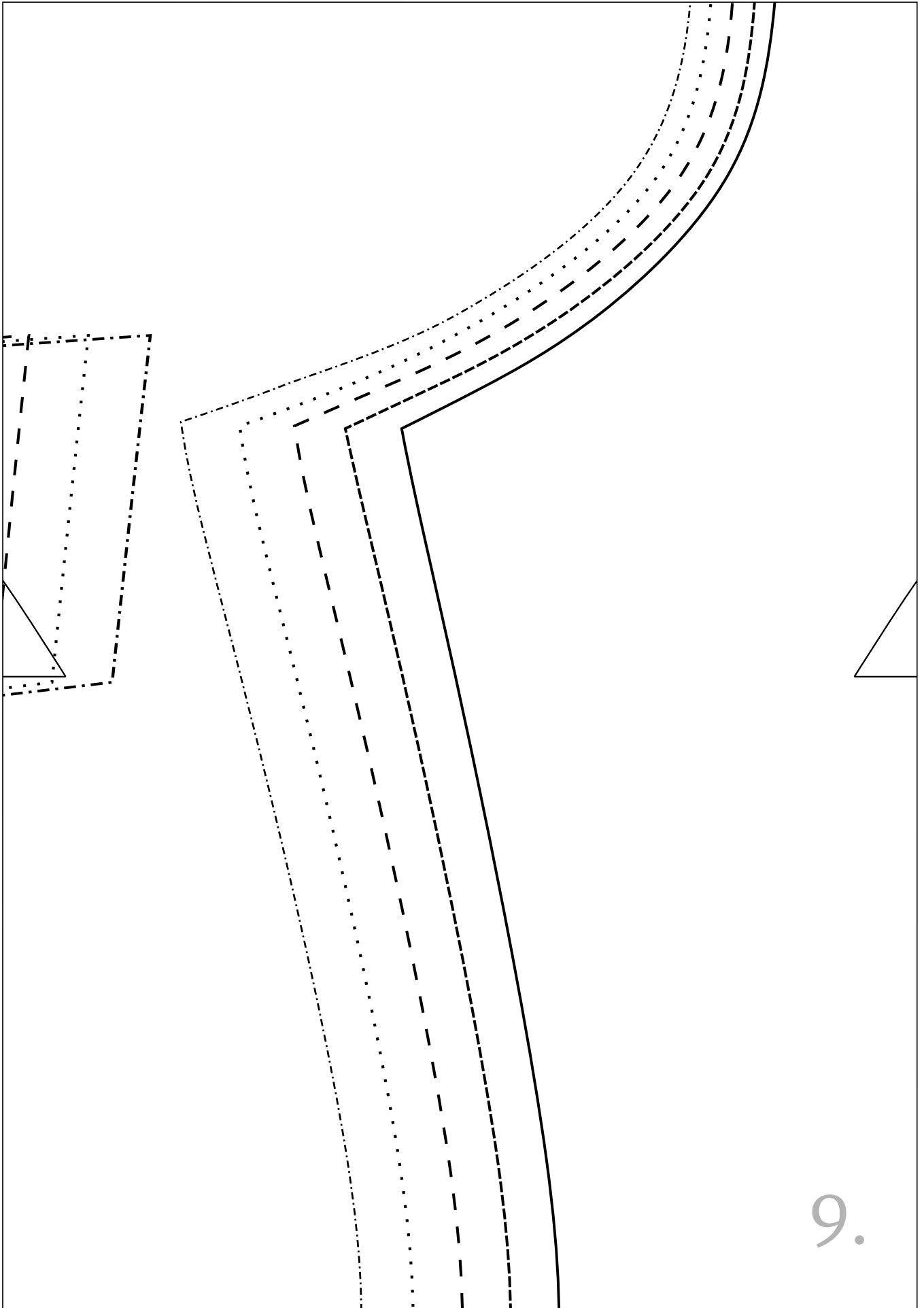

9.

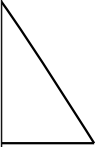

Kristy cowl neck dress
front panel
1 det with fold

ANNA
THE TAILOR

annathetailor.com
instagram: annathetailor
youtube: annathetailor

fold

11

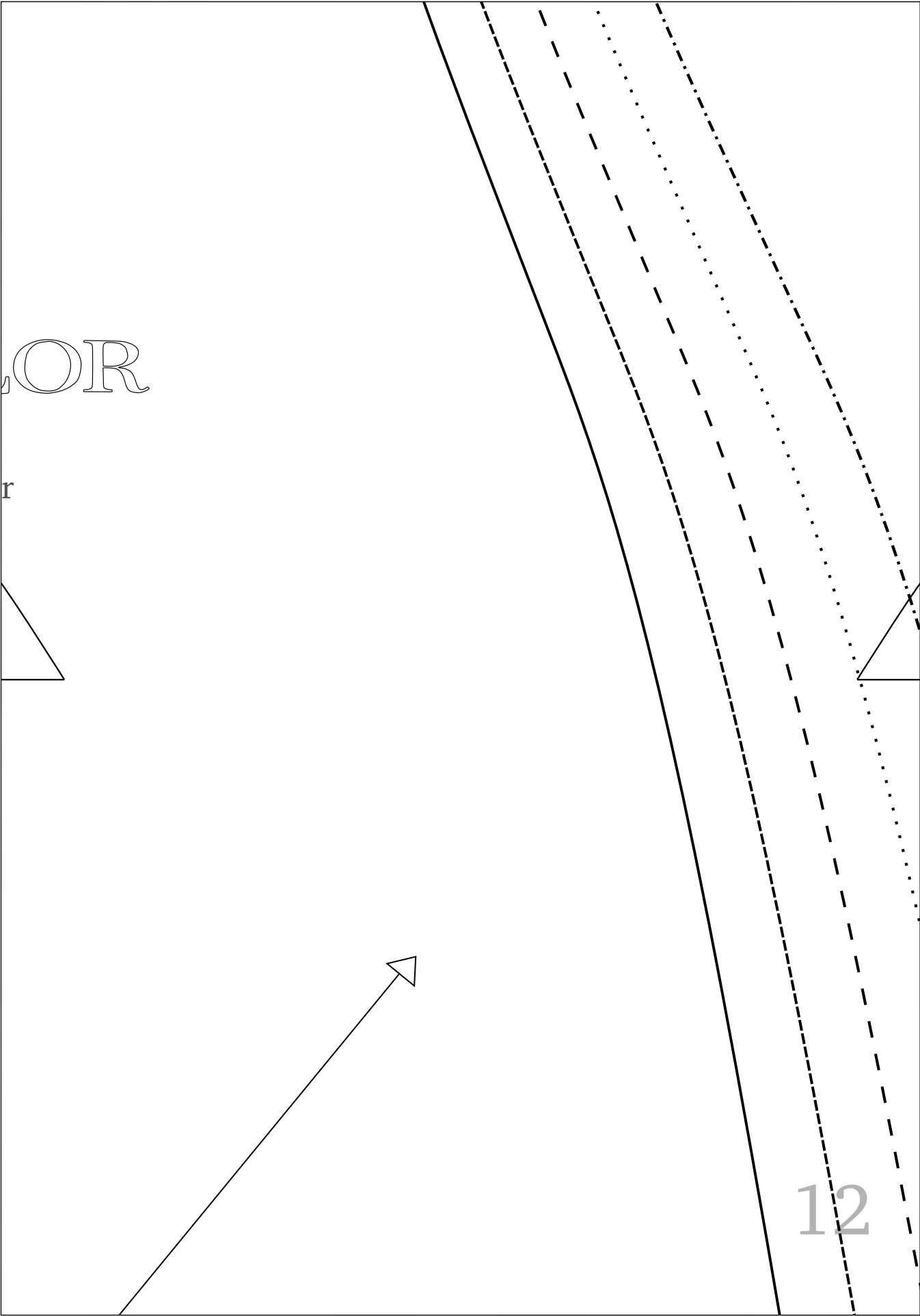

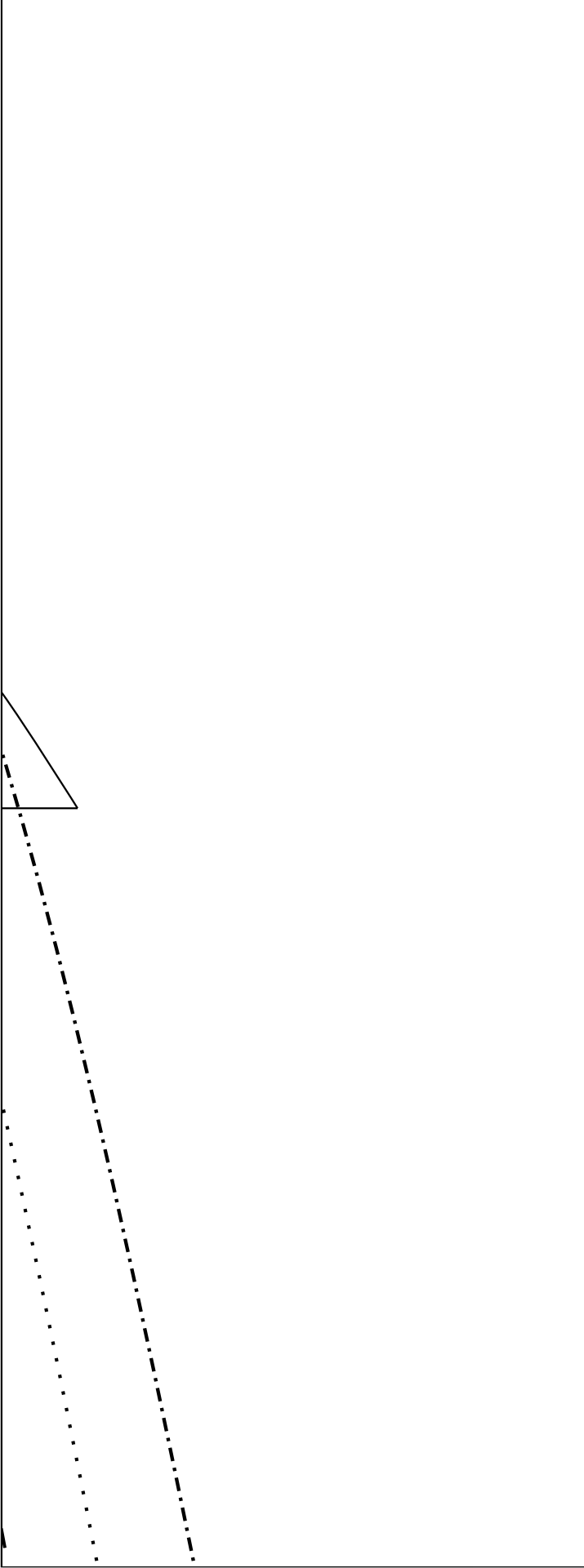

cowl neck dress **straps 2 det**

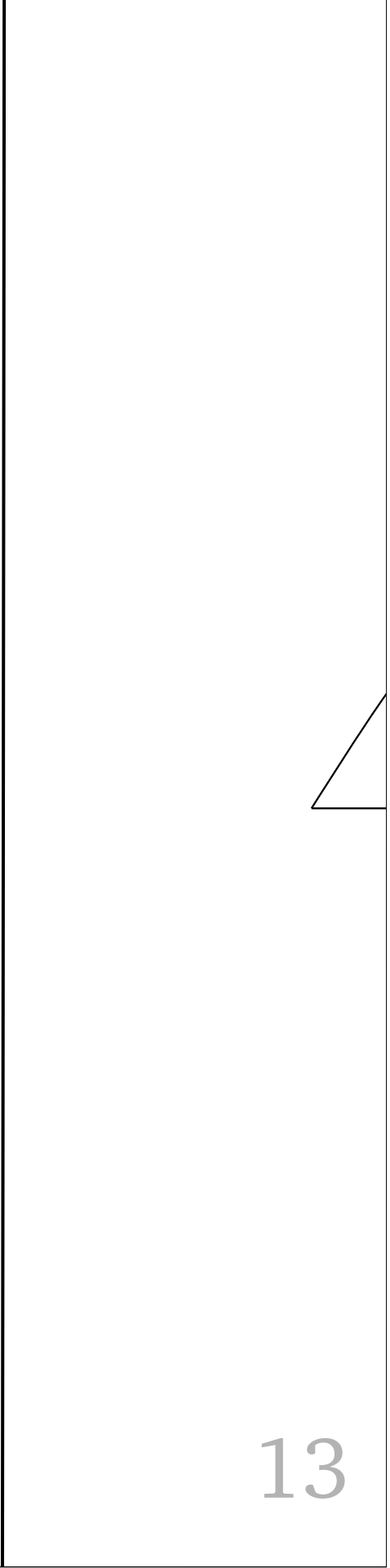

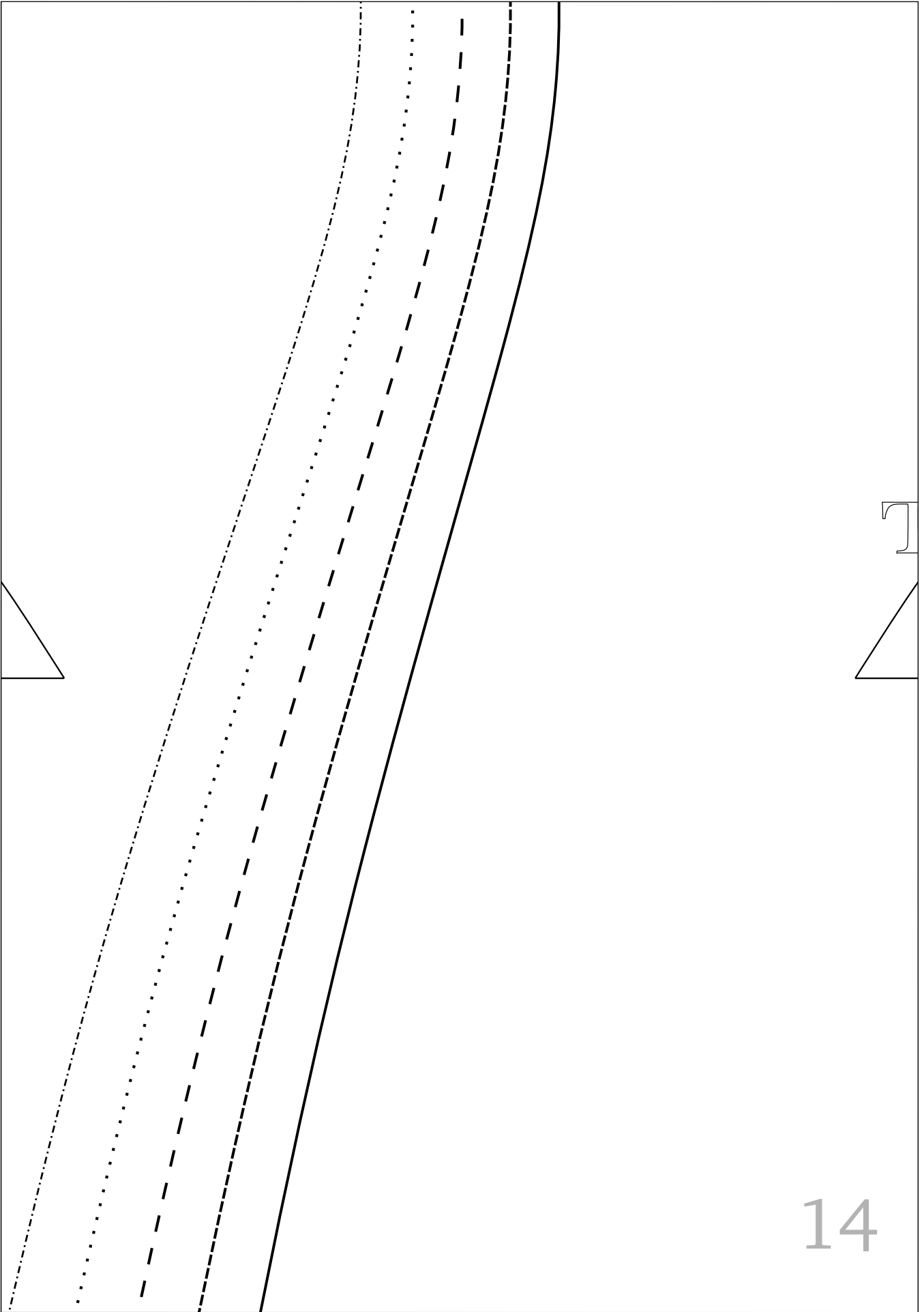

ANNA
THE TAILOR

annathetailor.com
instagram: annathetailor
youtube: annathetailor

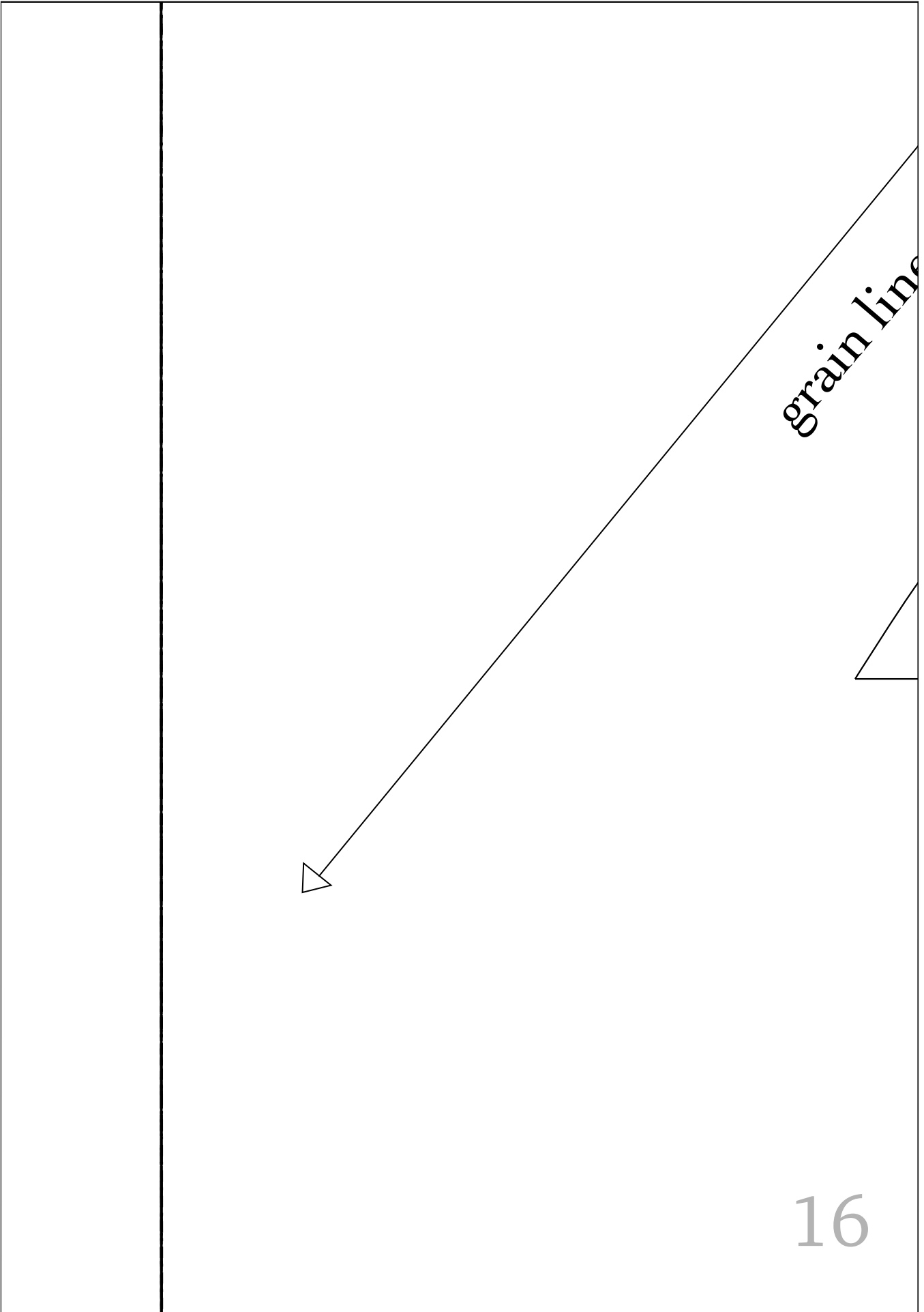

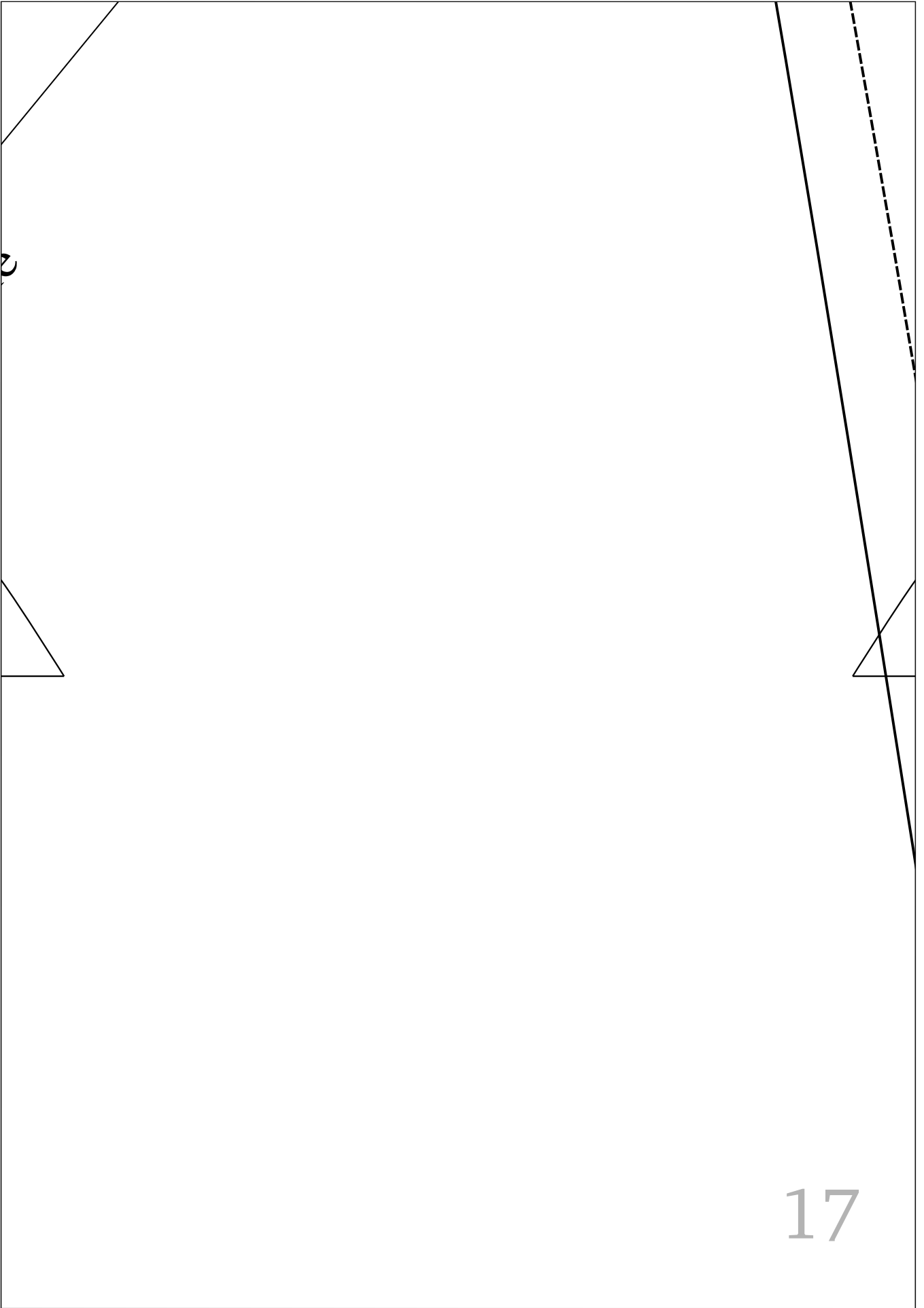

Kristy

18

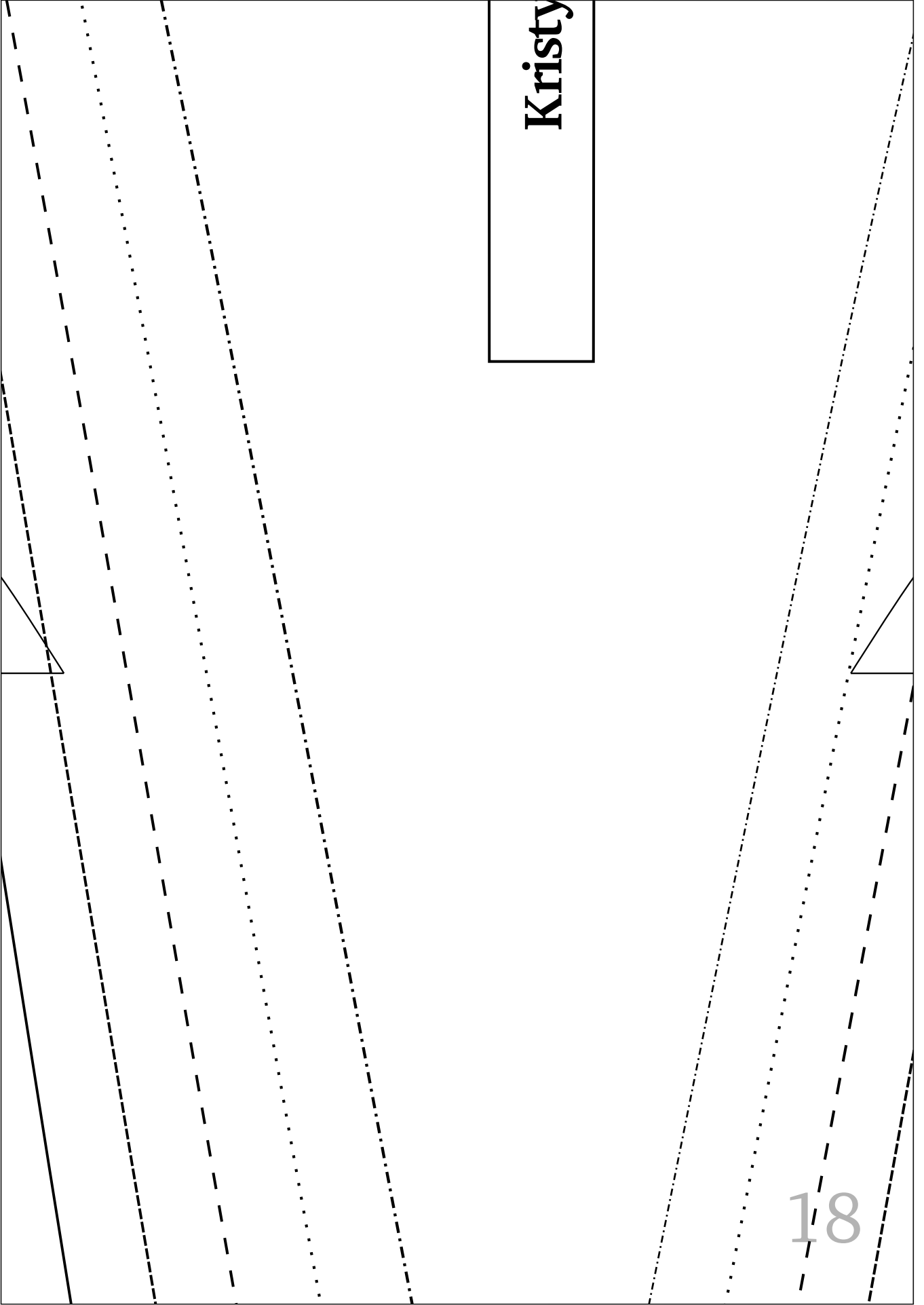

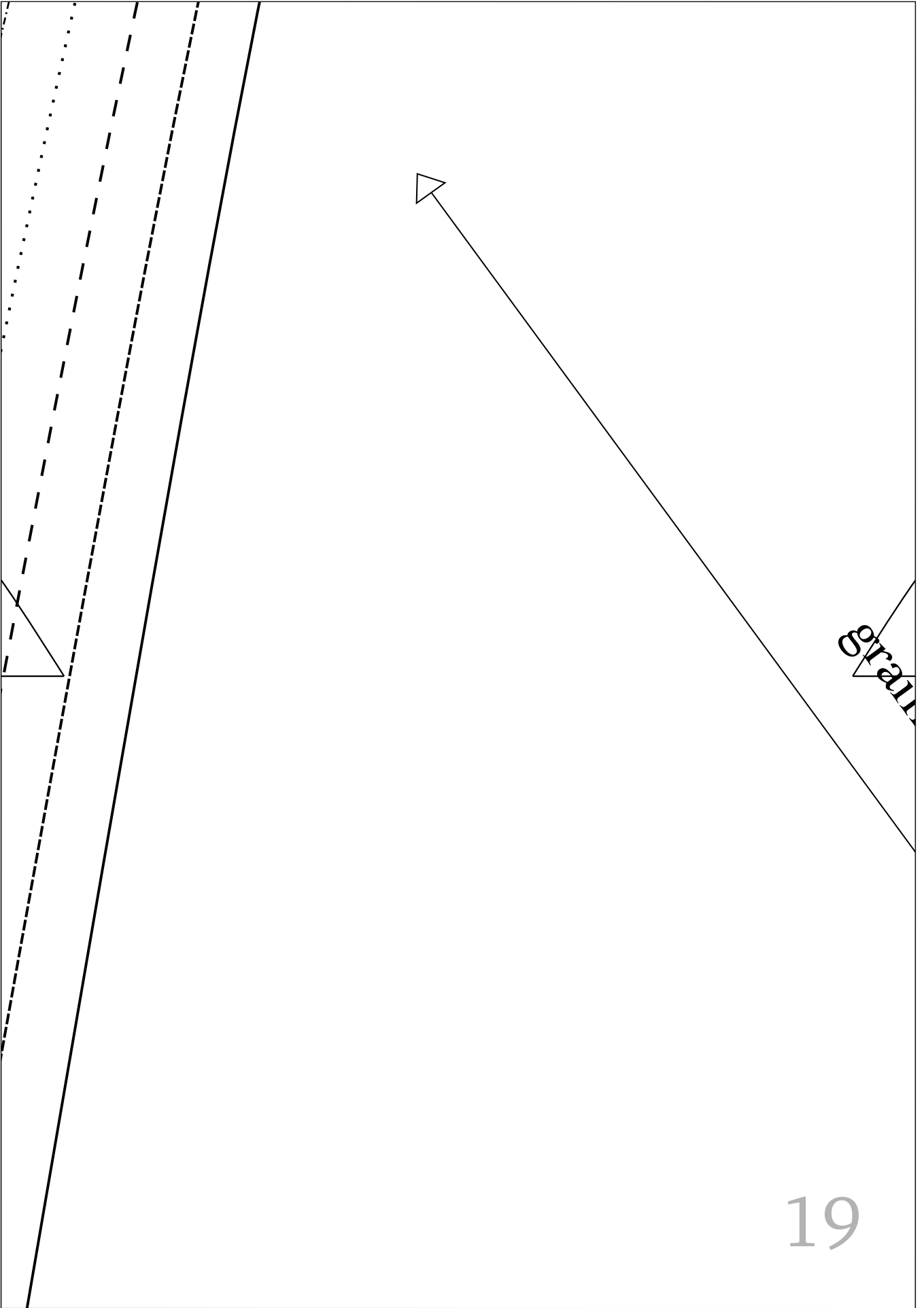

p

n line

