

# MAKE MY LEMONADE

ALDO  
34 - 48

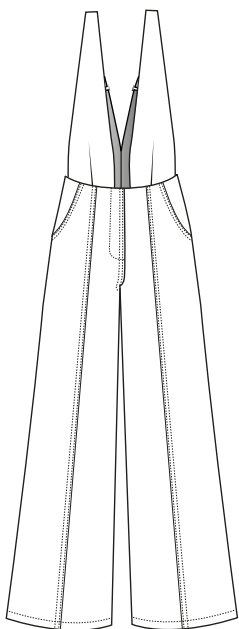

## INFOS / TIPS

- Ce patron comporte 11 pièces.
- Les valeurs de couture sont incluses et sont de 1cm sauf indications contraires.
- Ce modèle est près du corps.
- Mesurez votre tour de taille et hanches et coupez selon la mesure la plus grande.
- This pattern includes 11 pieces.
- The seam allowance is included and is of 1 cm.
- This model is fitted.
- Take your waist and hips measurements. Cut according to the biggest size.

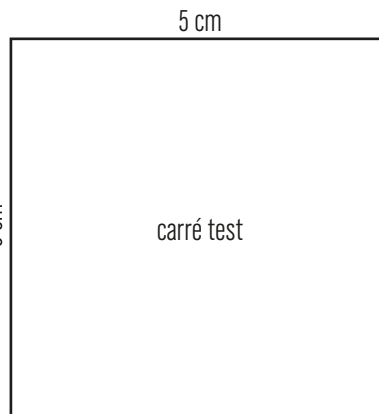

## TAILLES / SIZE

	34
	36
	38
	40
	42
	44
	46
	48

## LÉGENDE / KEY

	au pli / on the fold
	droit fil / straight grain D.F / S.G
	cran / notch
	pli / pleat
	pointage / circle
	à thermocoller / with interfacing

1 A

1 A

6

MAKE MY LEMONADE

\*\*\*

ALDO

PROPRETÉ POCHE /  
POCKET FACING x 2  
(couper 1x à l'endroit,  
1x à l'envers)  
(cut 1x on the right side,  
1x on the wrong side)

1 B

1 B

1 B

côté / side

entrée de poche / pocket's entry

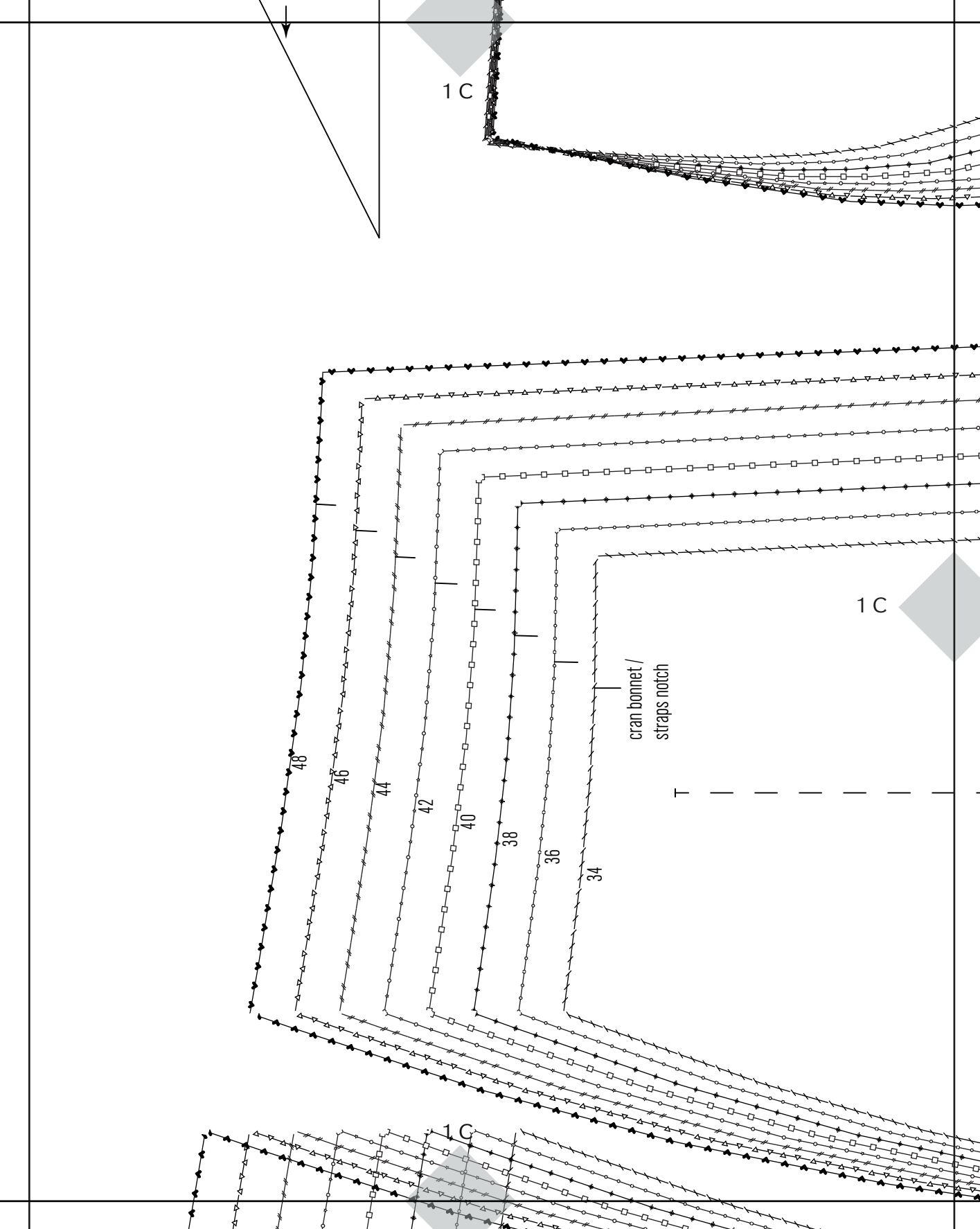

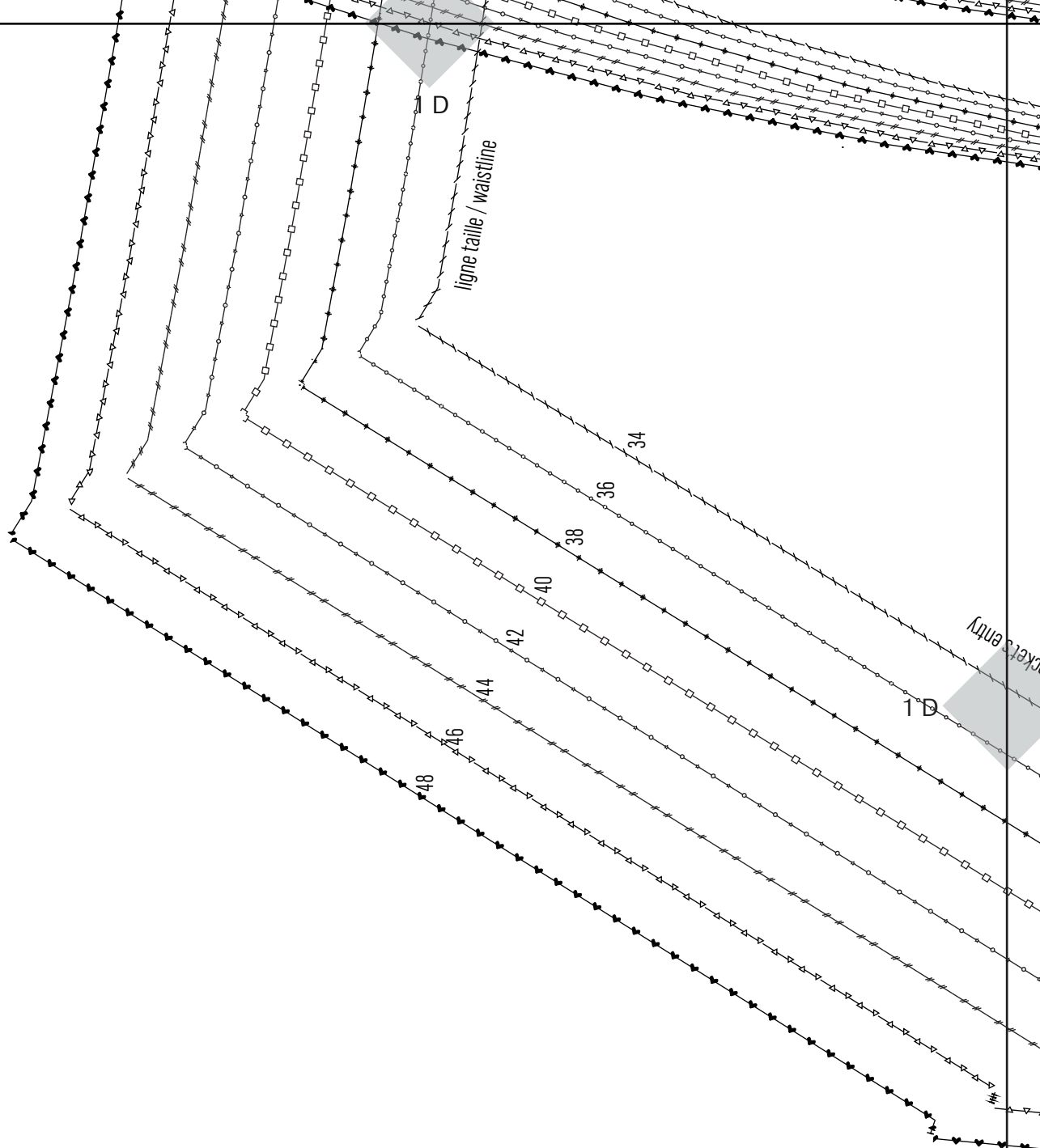

sketch entry

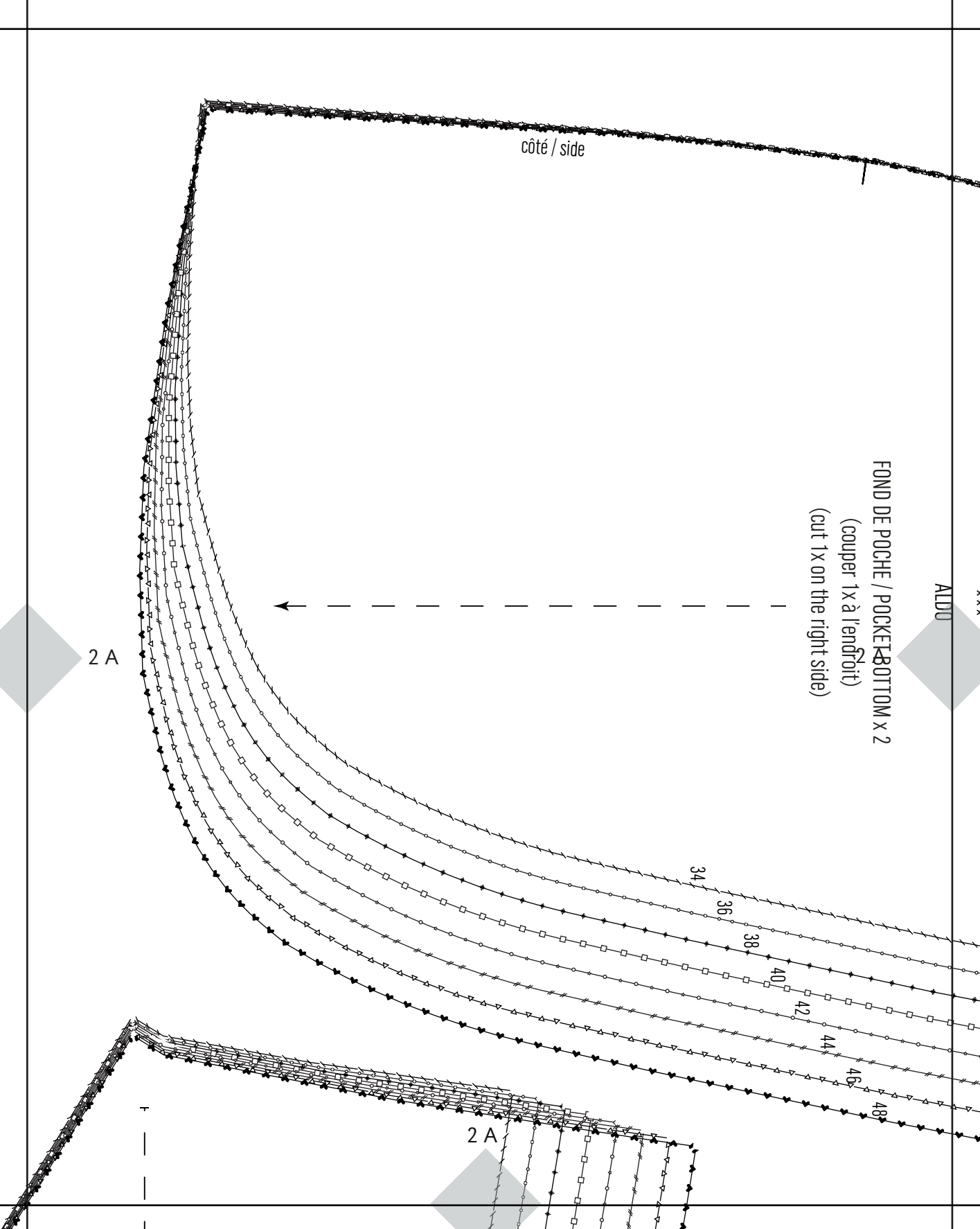

4

MAKE MY LEMONADE

\*\*\*

2 BALDO

POCHE / POCKET x 2  
(couper 1x à l'endroit)  
(cut 1x on the right side)

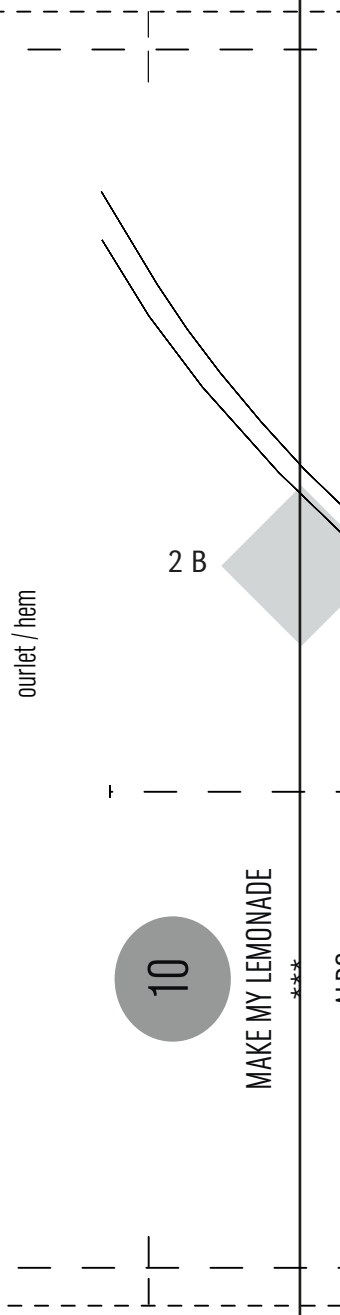
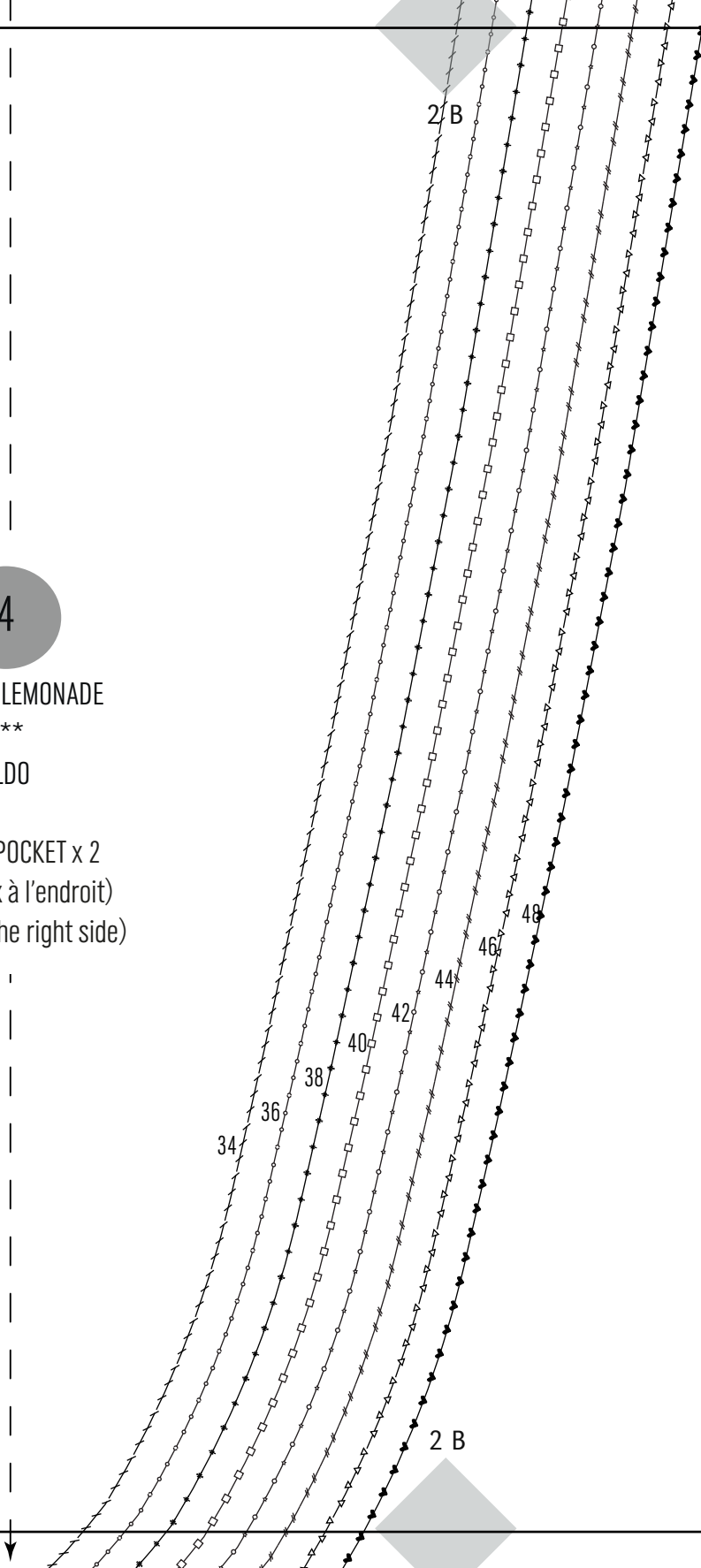

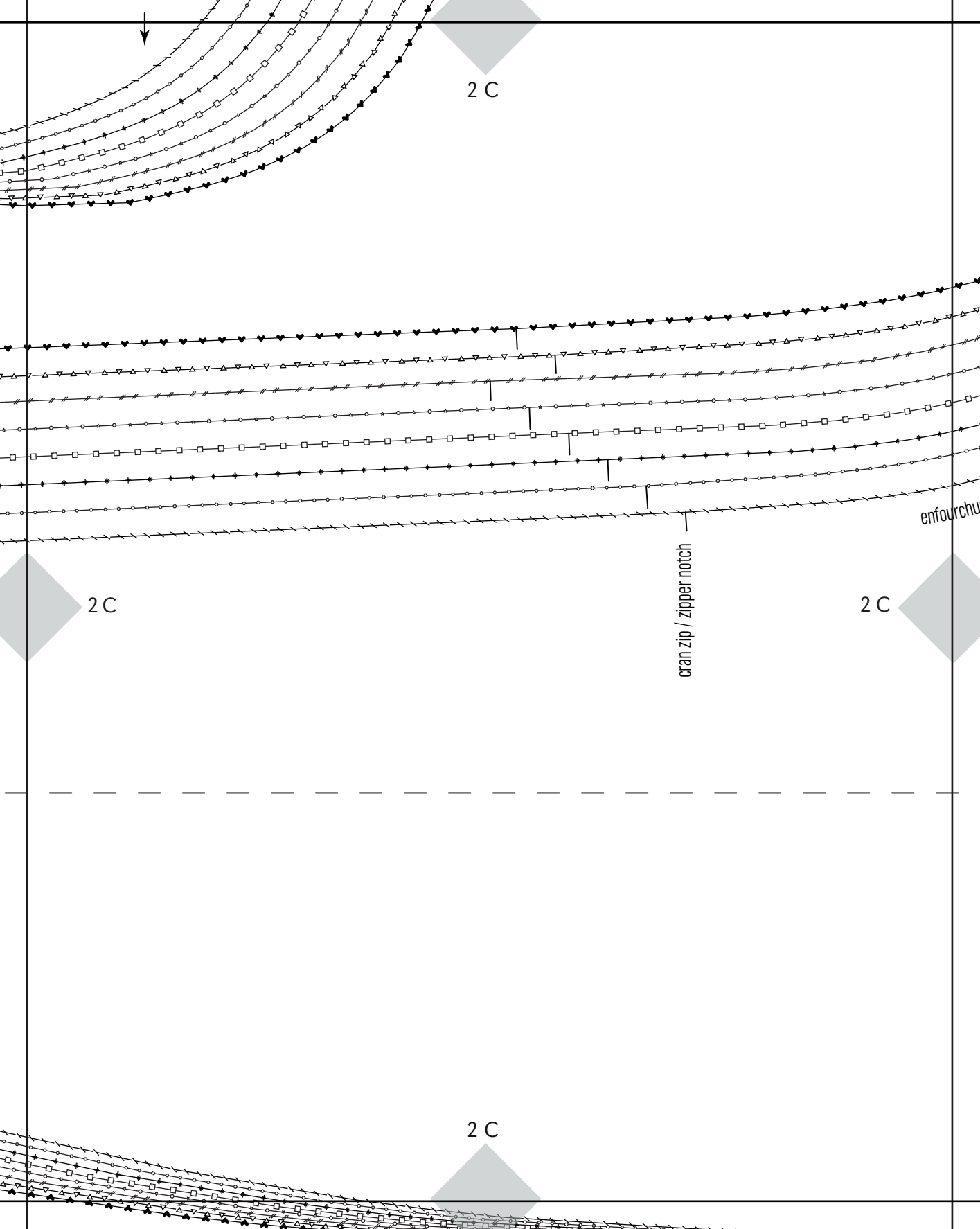

2 D

2 D

entre de poche / pocket's entry

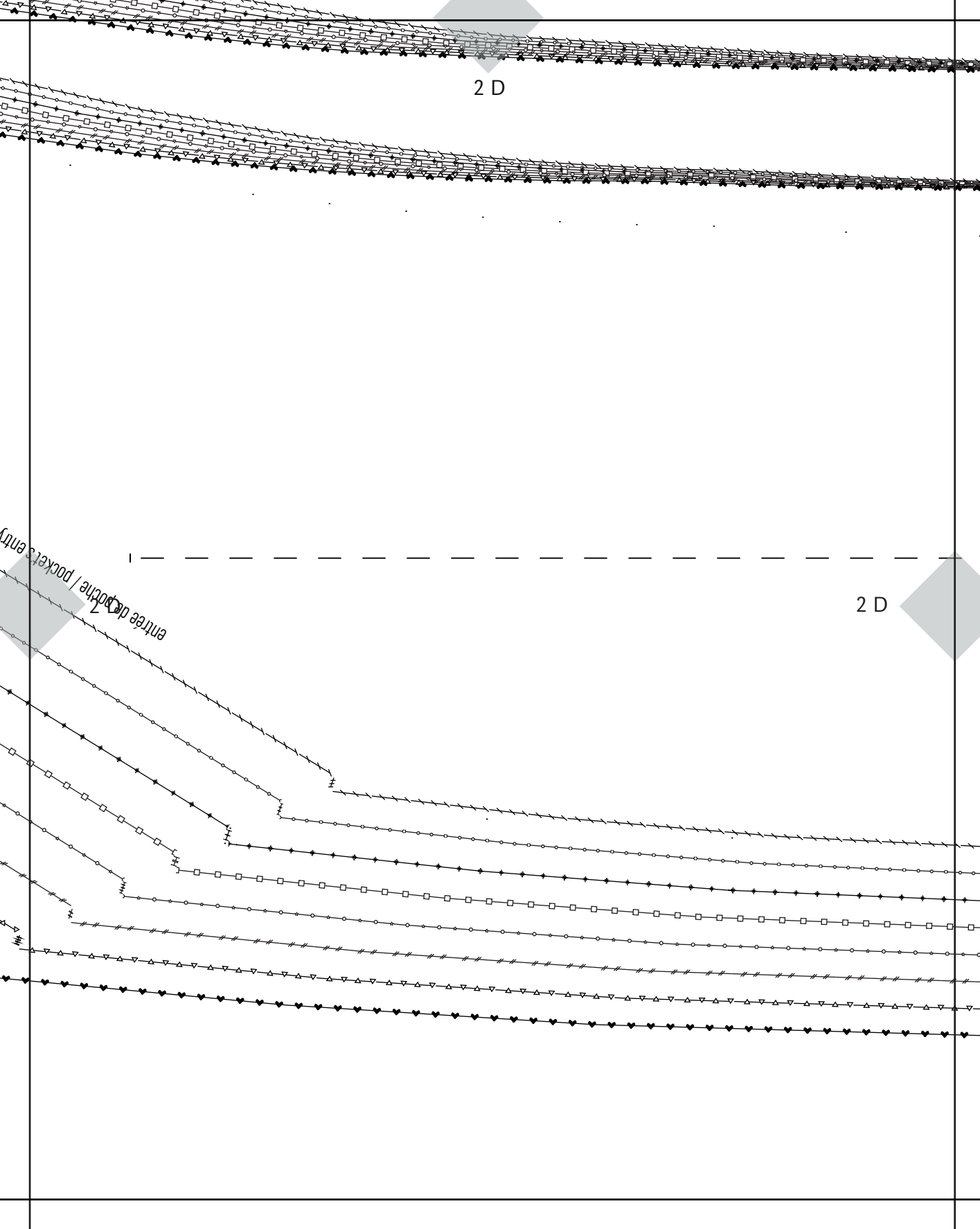

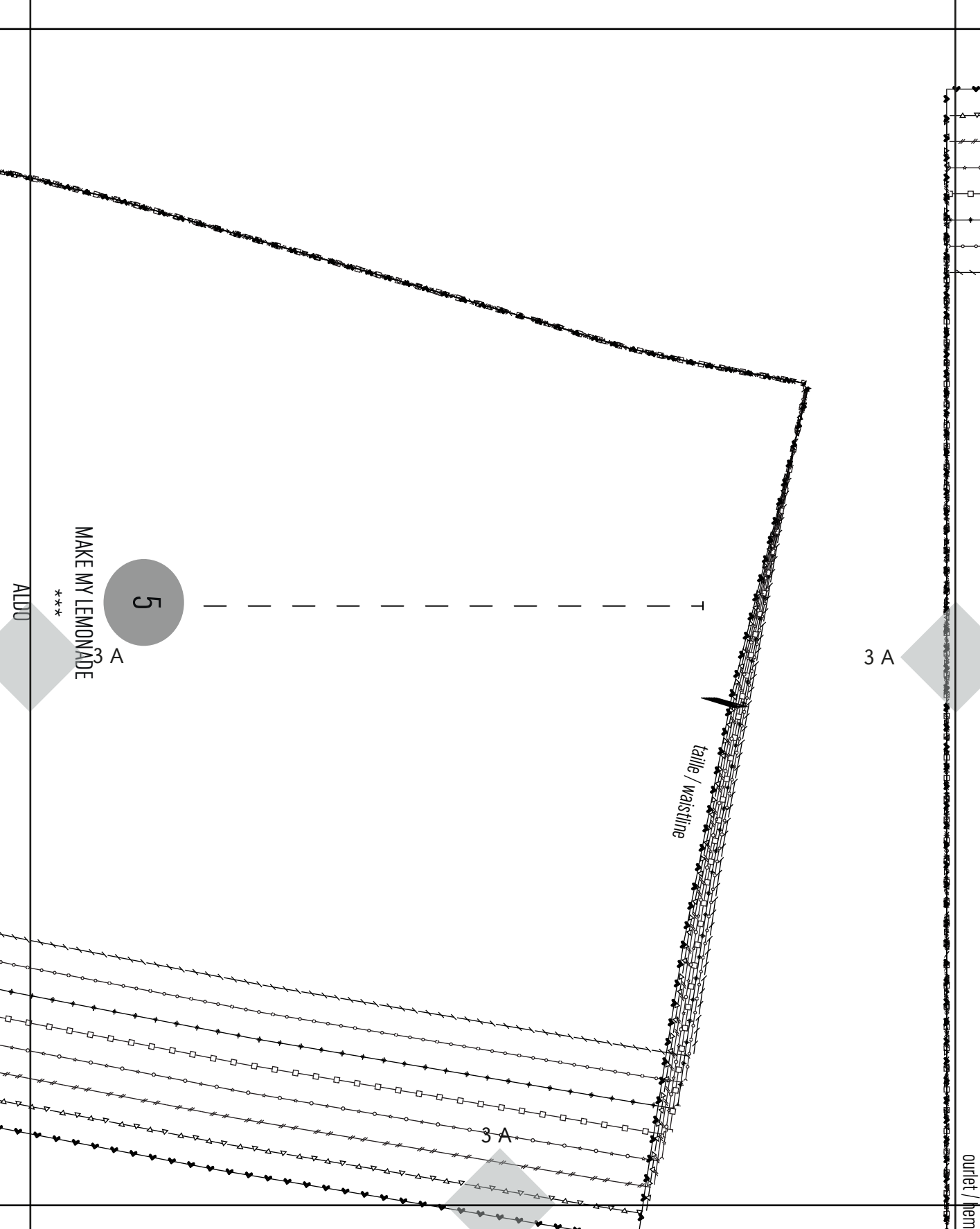

ALDO

POCHE PLAQUÉE DOS /  
BACK PATCHED POCKET x 2  
(couper 2x à l'endroit)  
(cut 2x on the right side)

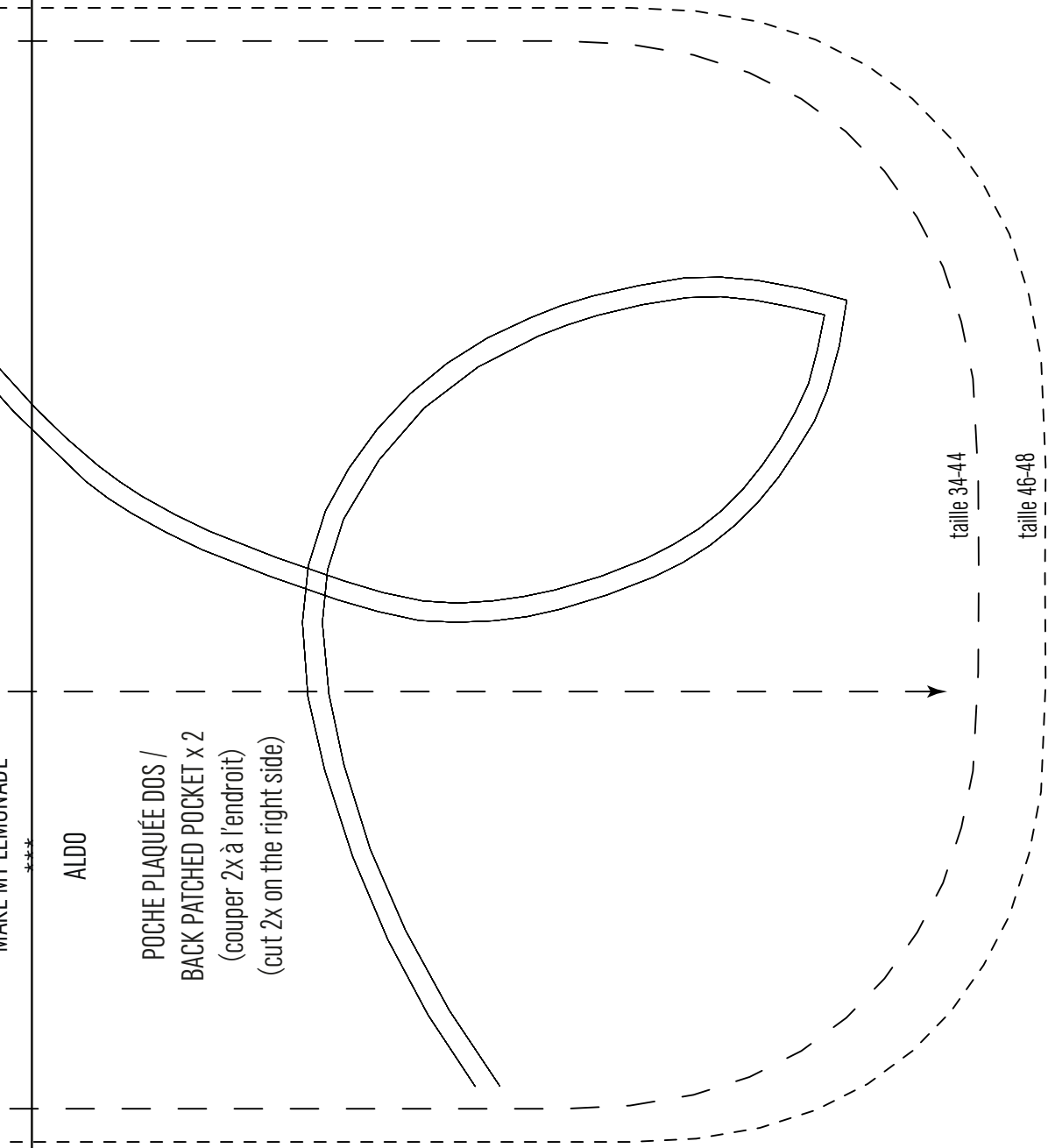

taille 34-44

taille 46-48

3 B

3 B

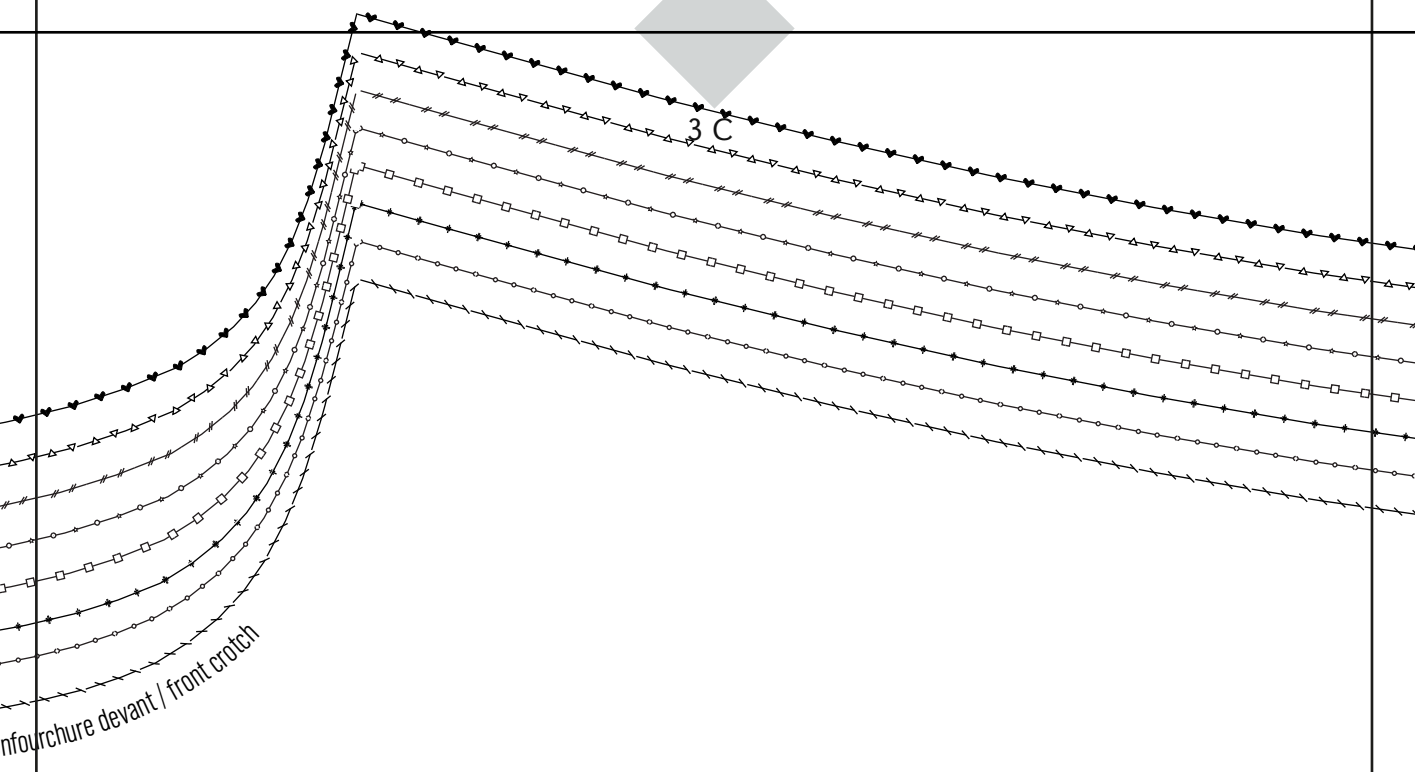

3 C

2

MAKE MY LEMONADE

\*\*\*

ALDO

JAMBE DEVANT / FRONT LEG x 2

(couper 1x à l'endroit, 1x à l'envers)

(cut 1x on the right side, 1x on the wrong side)

3 C

3 C

3 D

3 D

3 D

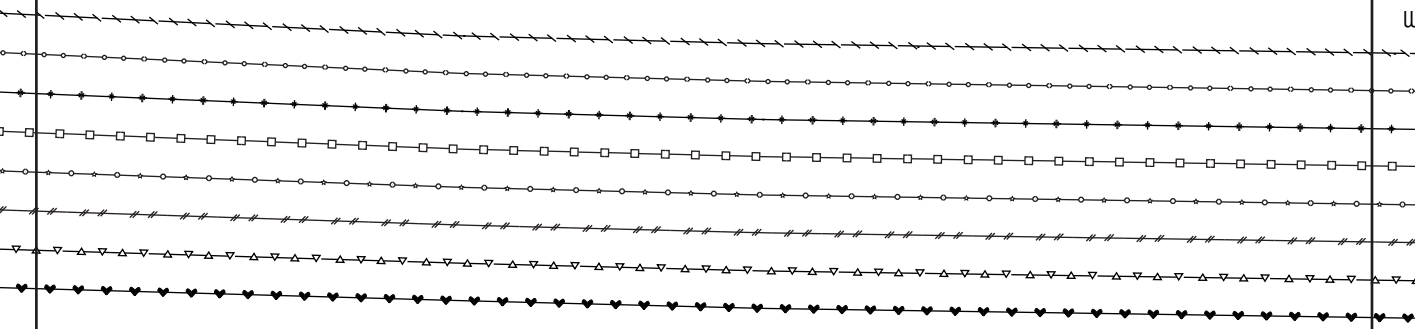

U

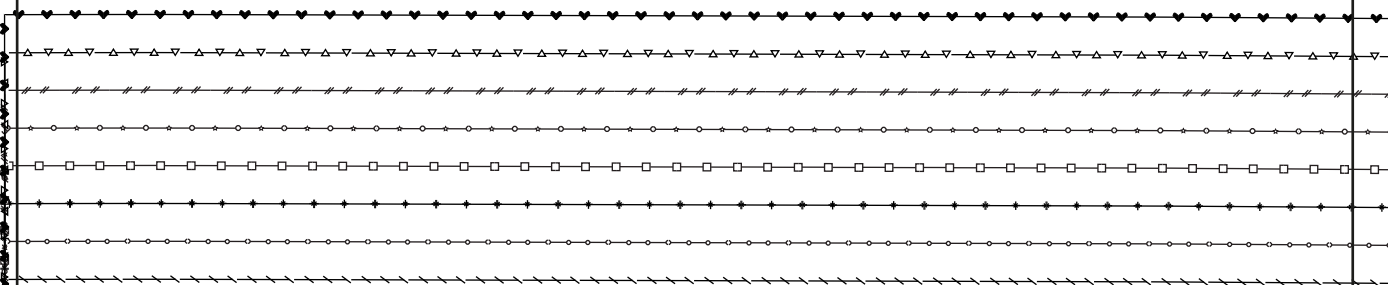

4 A

4 A

4 A

outlet / mem

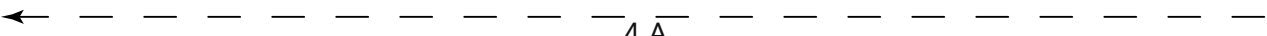

4 B

4 B

4 B

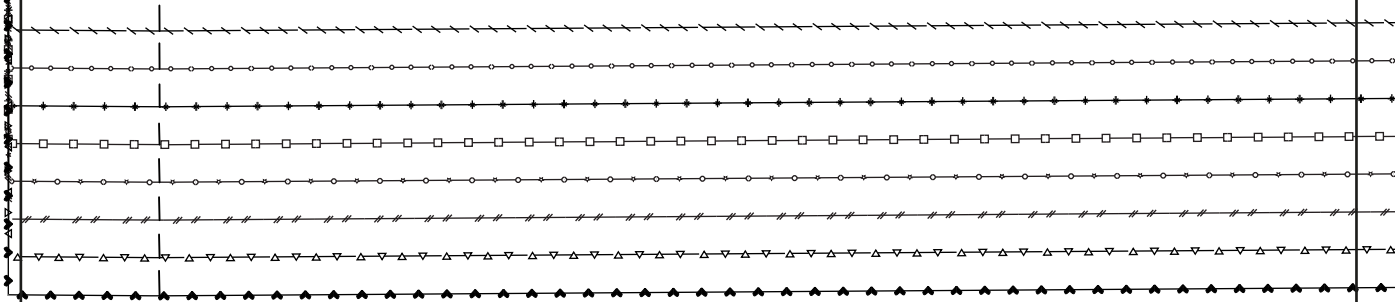

4 B

4 C

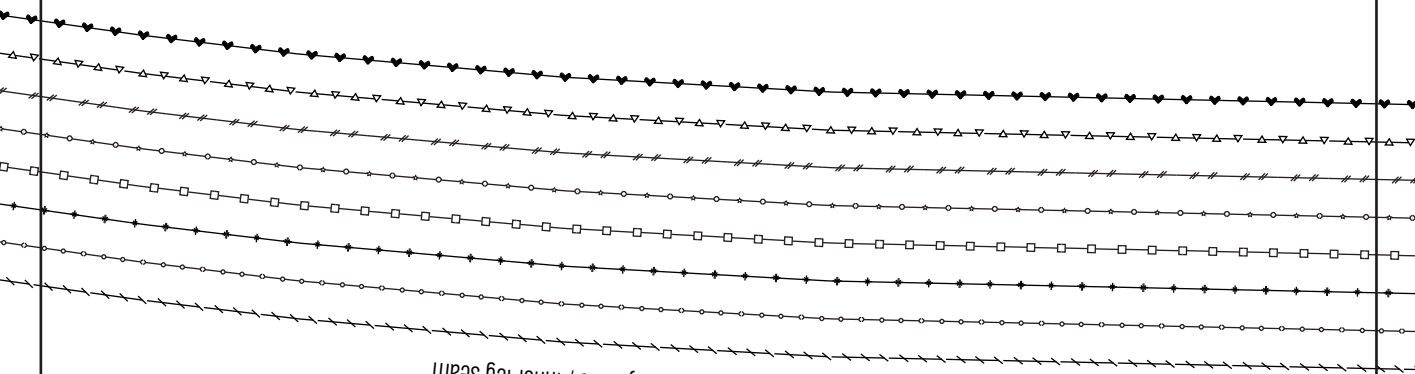

*Intérieur de jambe / inner leg seam*

4 C

4 C

4 C

4 D

4 D

3

MAKE MY LEMONADE

\*\*\*

ALDO

EMPIÈCEMENT DEVANT / FRONT YOKE x 2

(couper 1x à l'endroit, 1x à l'envers)

(cut 1x on the right side, 1x on the wrong side)

ligne de côté / side seam

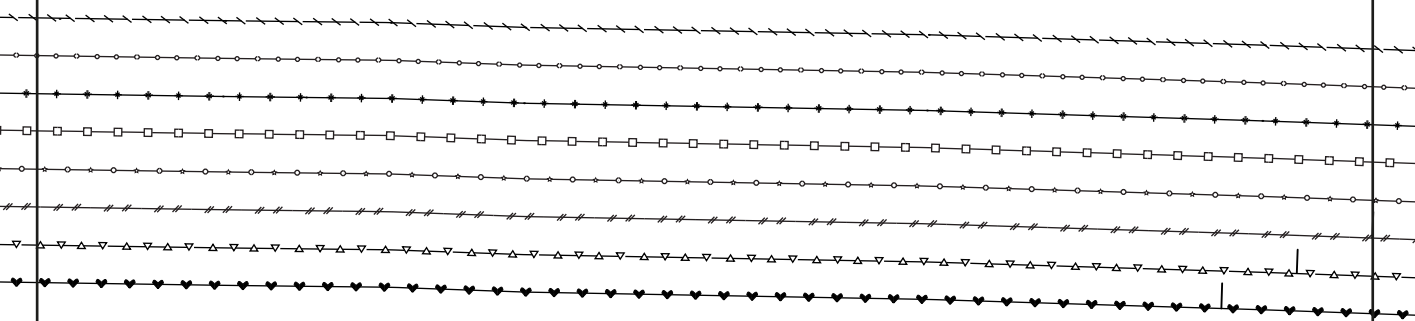

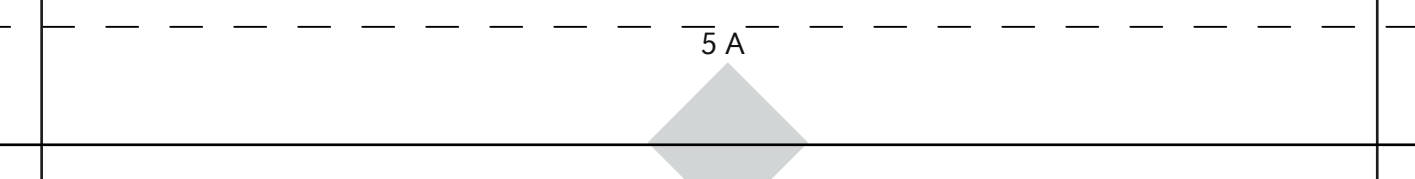
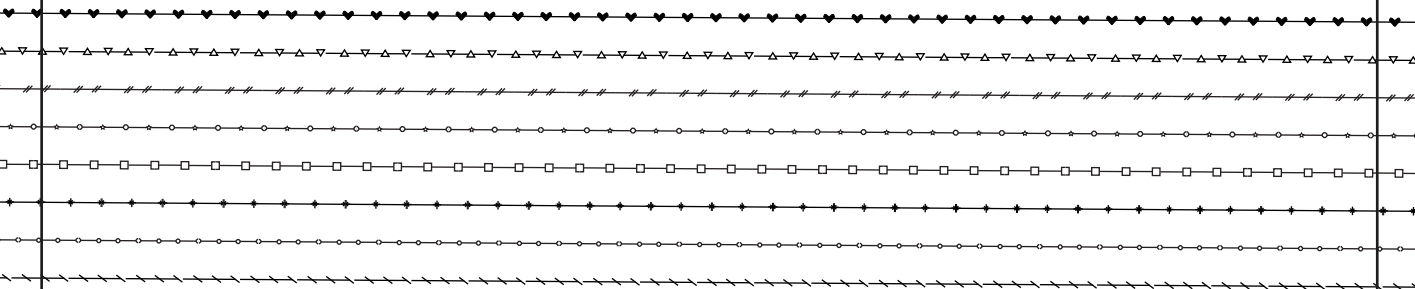

5 B

5 B

5 B

5 B

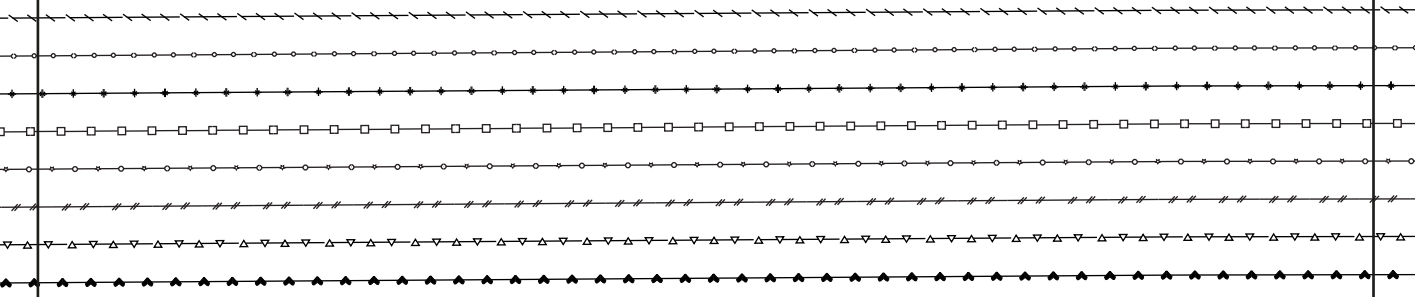

5 C

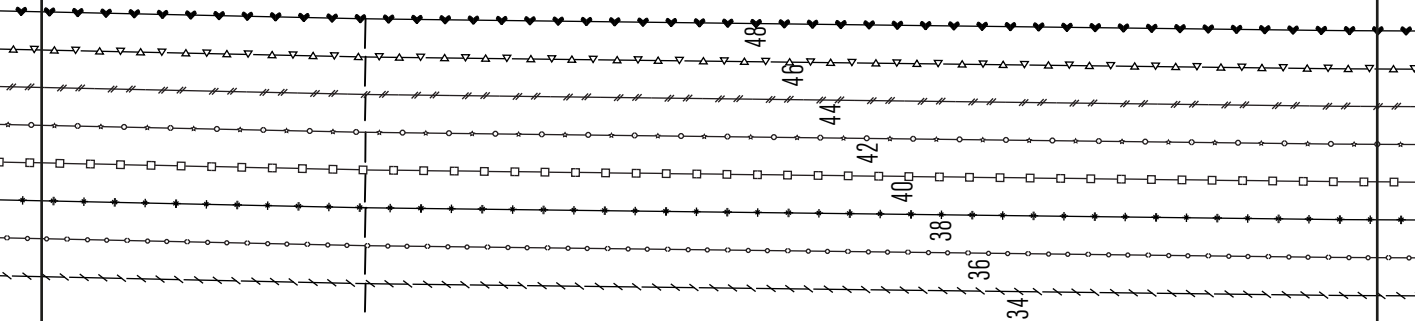

5 C

5 C

5 C

5 D

5 D

5 D

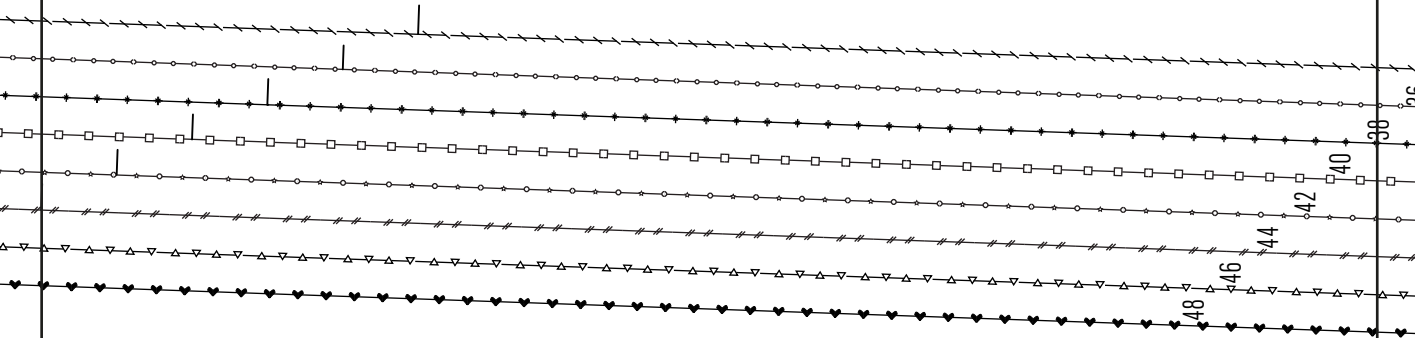

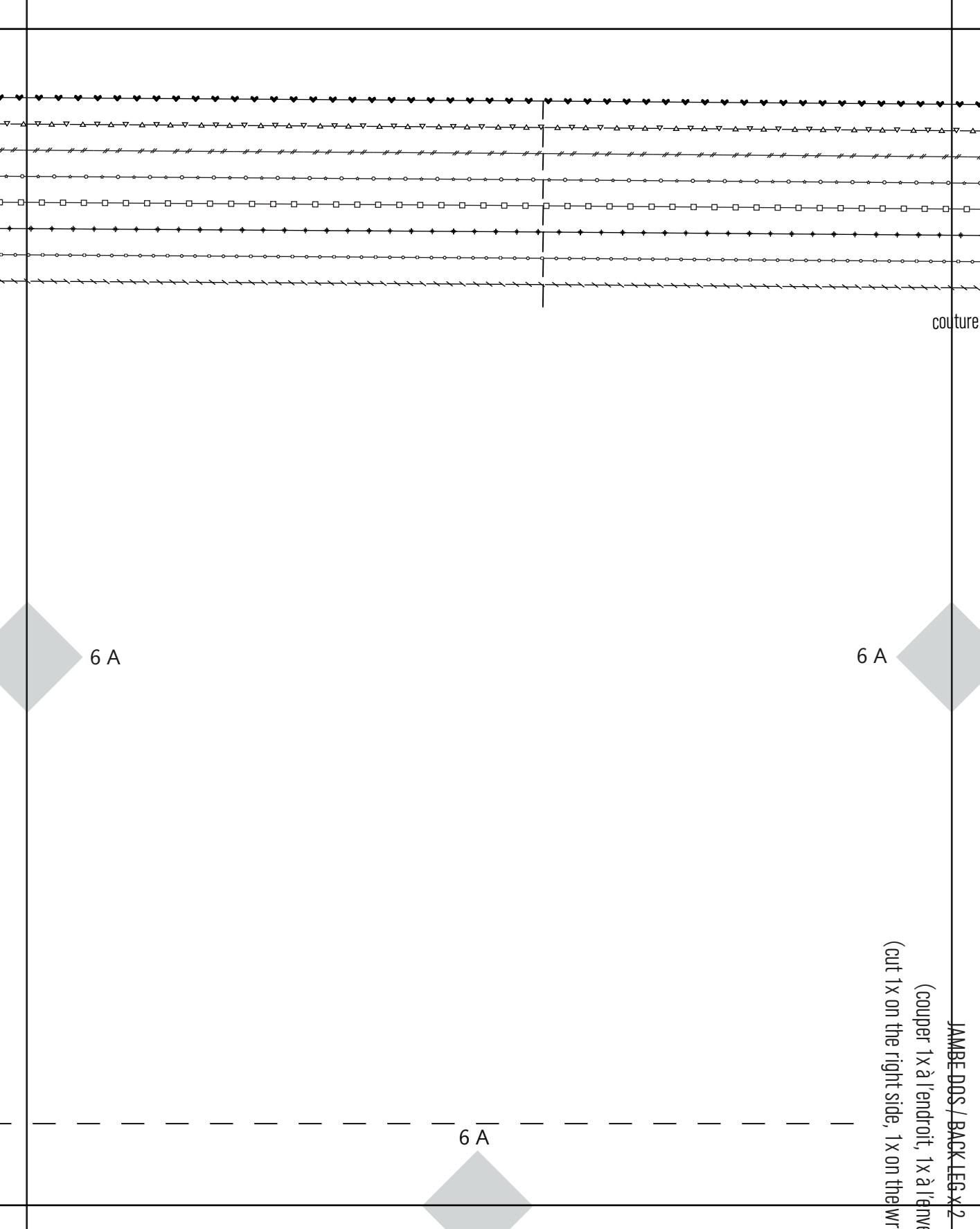

couture

6 A

6 A

6 A

JAMBE DQS / BACK LEG x 2

(couper 1x à l'endroit, 1x à l'envers)

(cut 1x on the right side, 1x on the wrong side)

(Invers)  
(the wrong side)

6 B

6 B

6 B

6 B

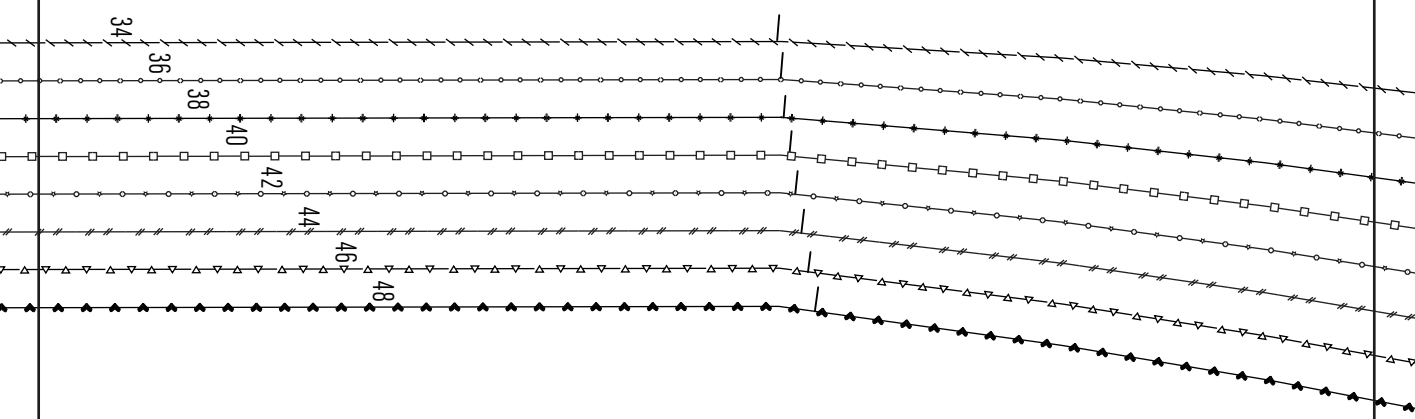

6 C

6 C

6 C

6 C

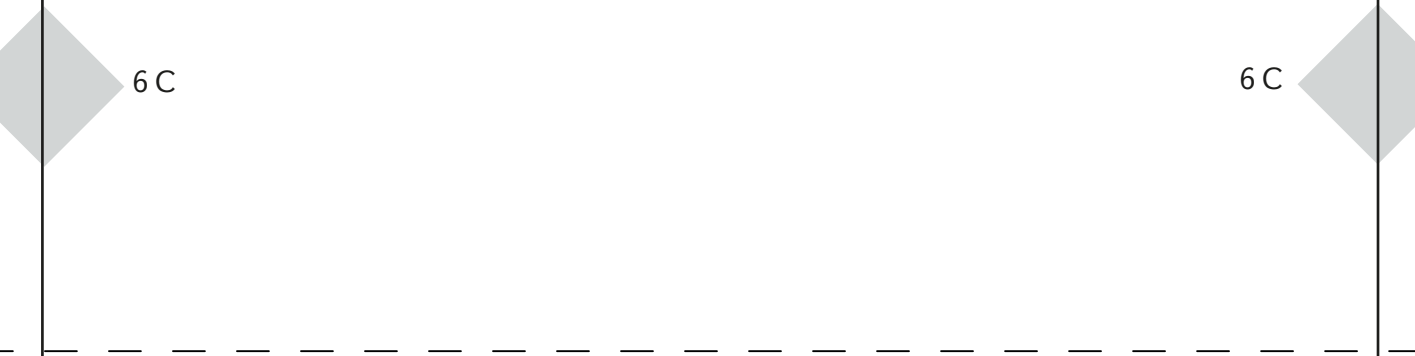
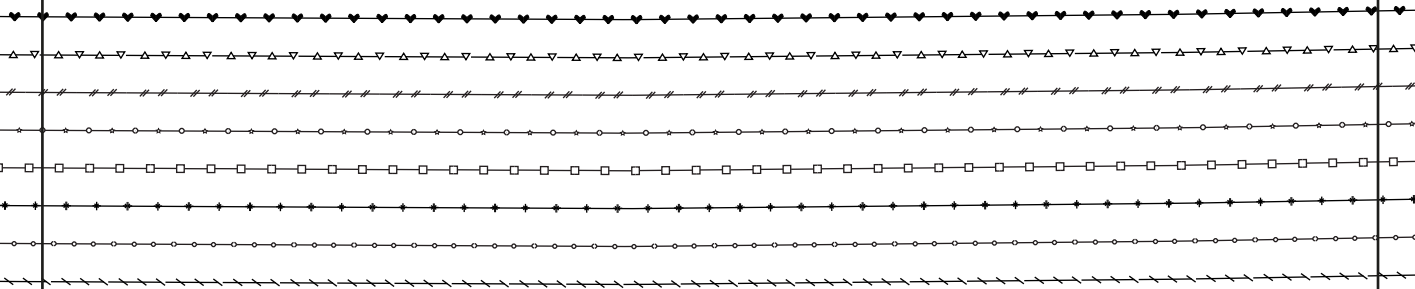

6 D

6 D

6 D

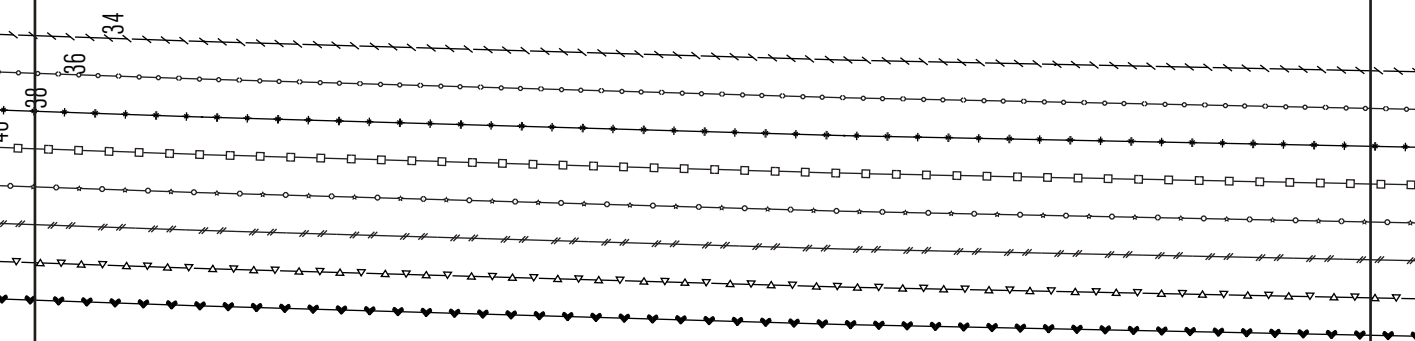

couture côté / side seam

38  
36  
34

7 A

7 A

MAKE MY LEMONADE

\*\*\*\*

ALDO



7 A

JAMBE DOS / BACK LEG X 2

(coursus 1v à l'endroit - 1v à l'envers)

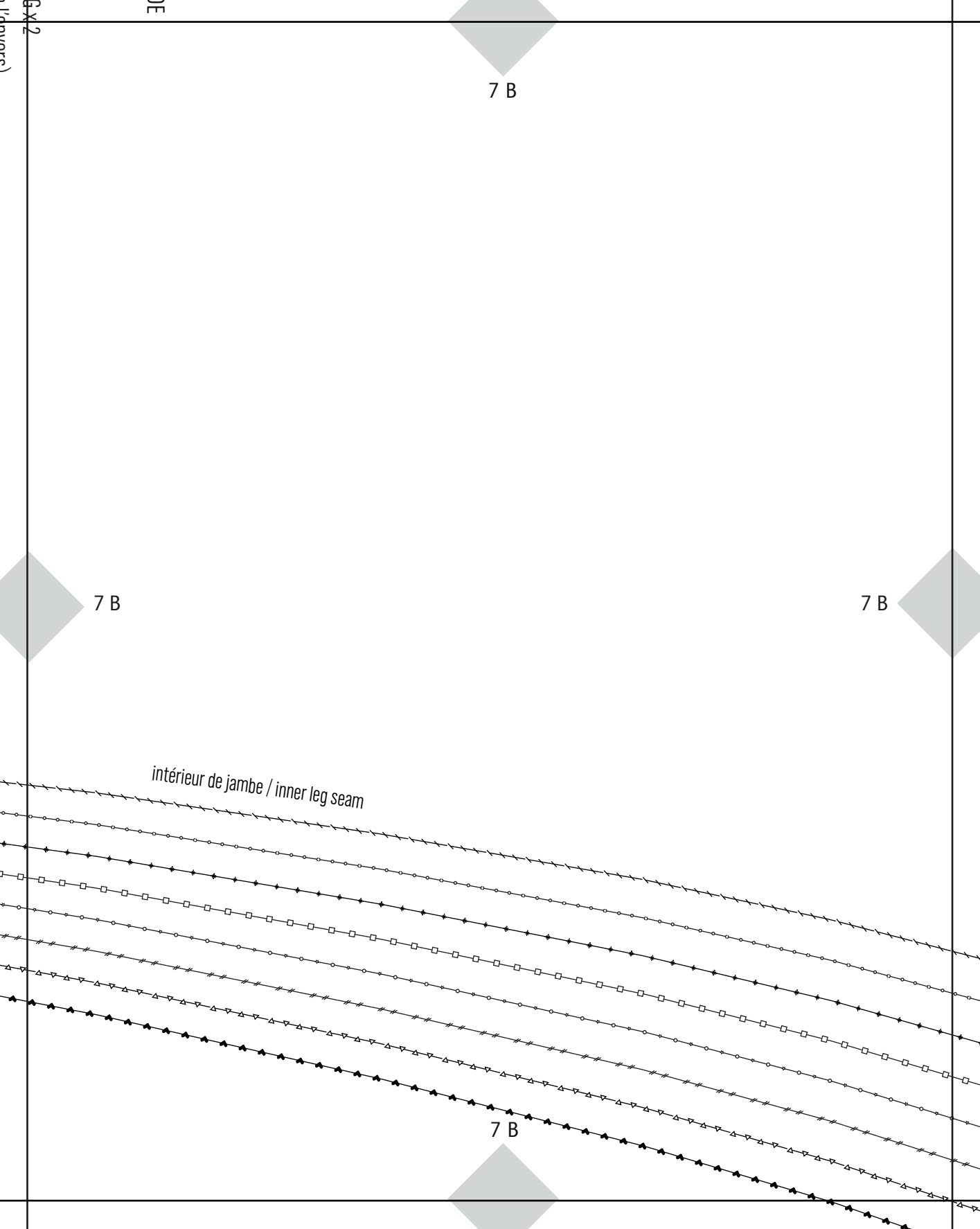

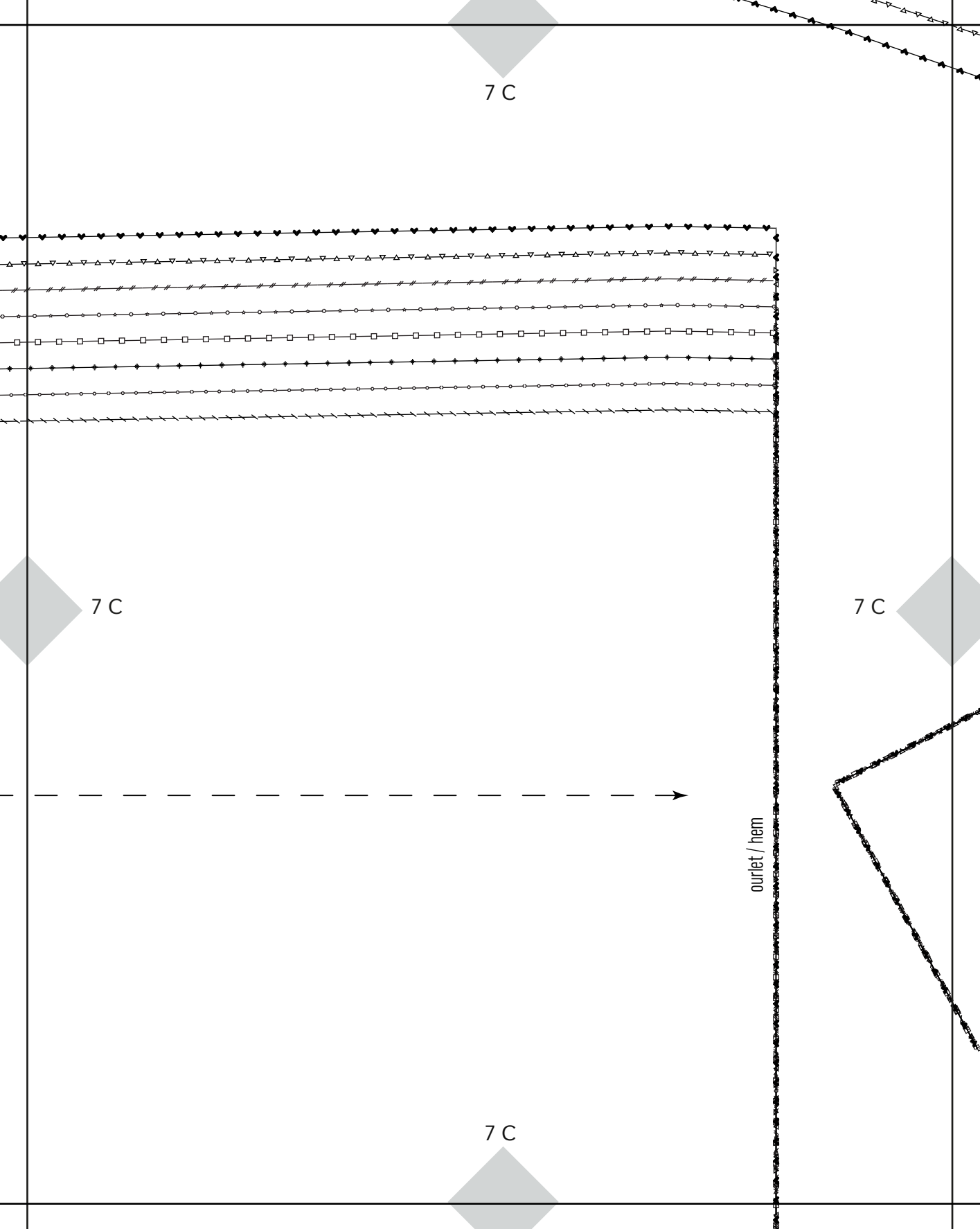

7C

7C

7C

7C

outlet / hem

7 D

7 D

outlet / hem

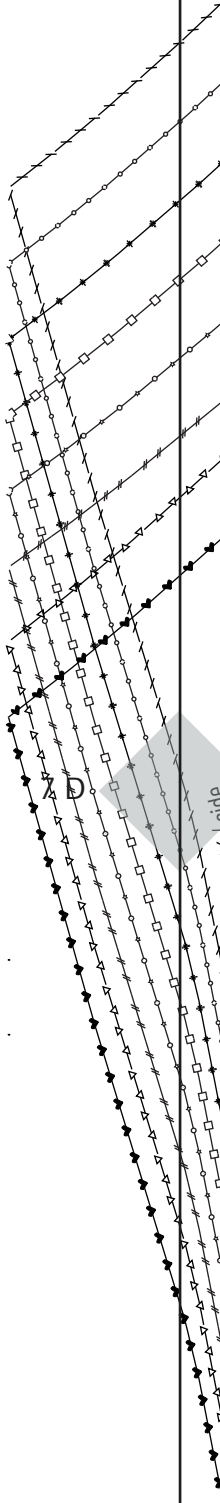

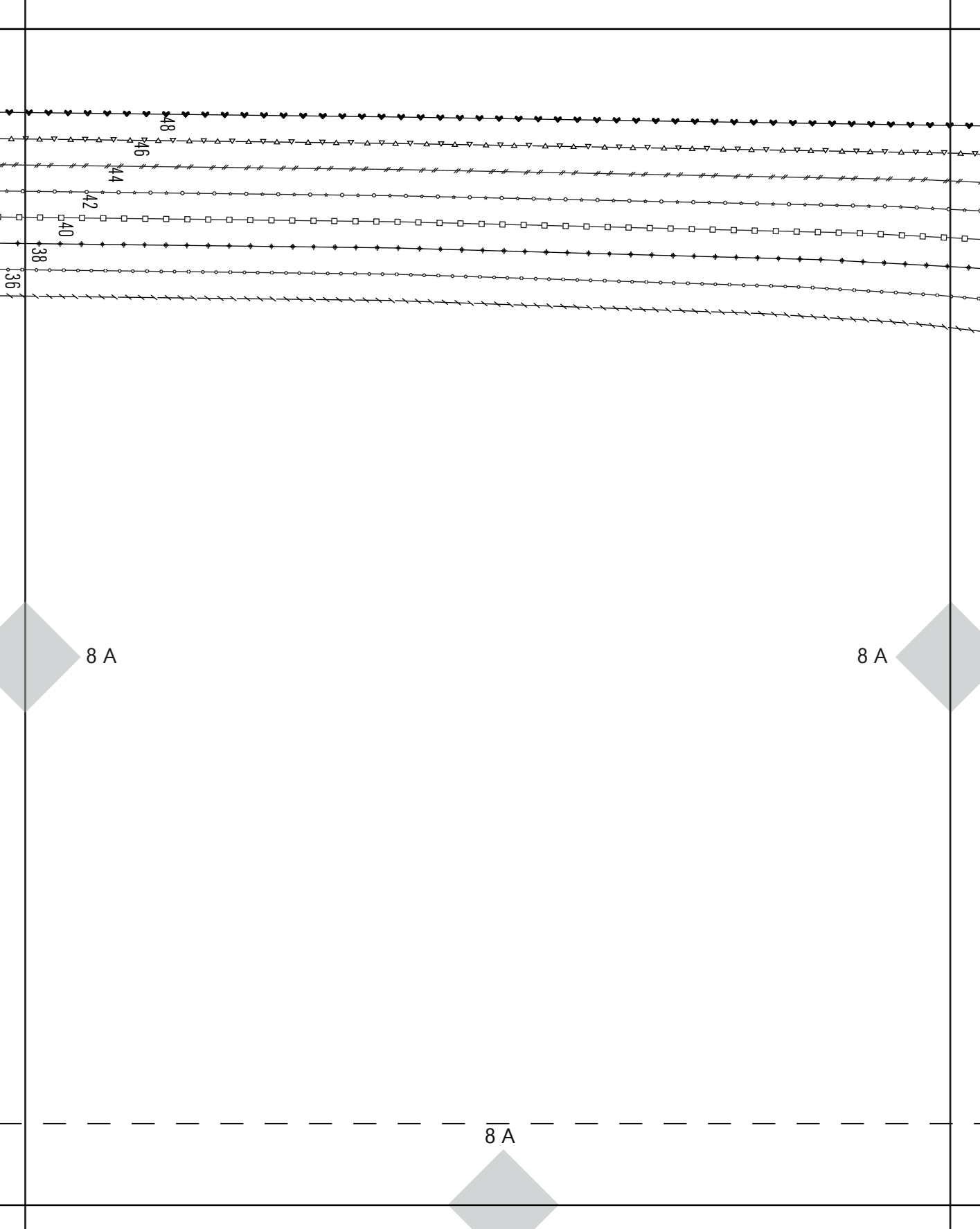

8 B

8 B

8 B

8 B

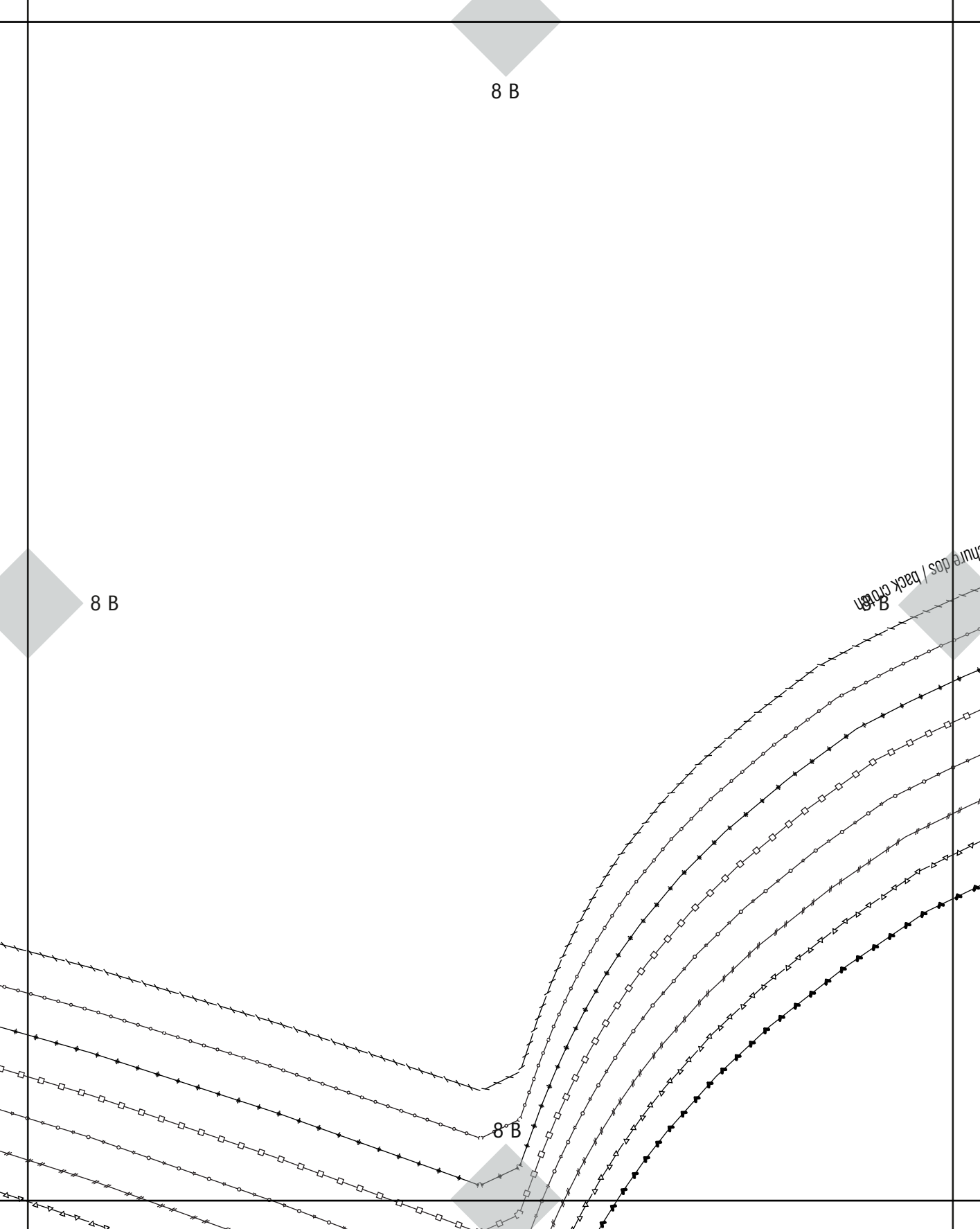

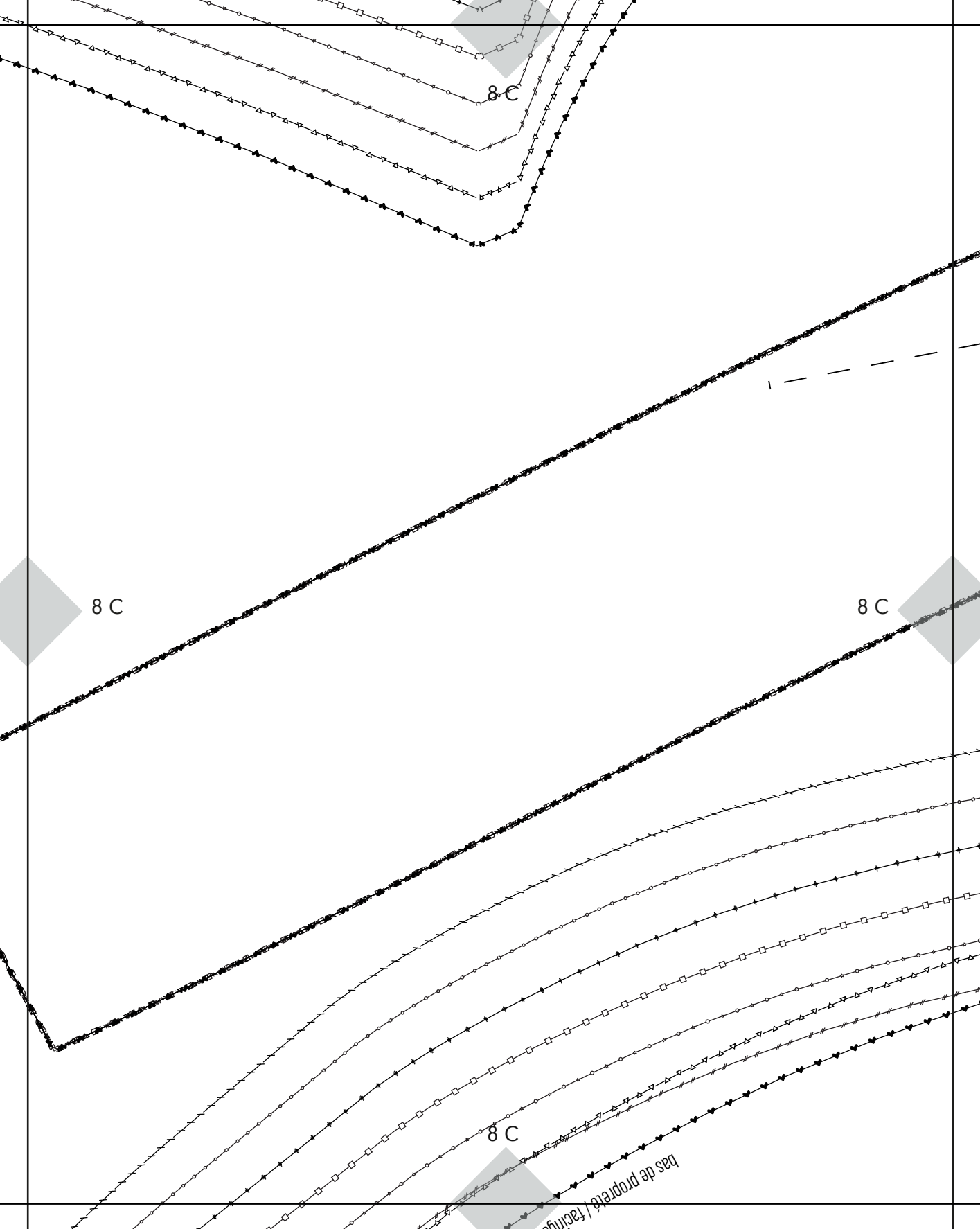

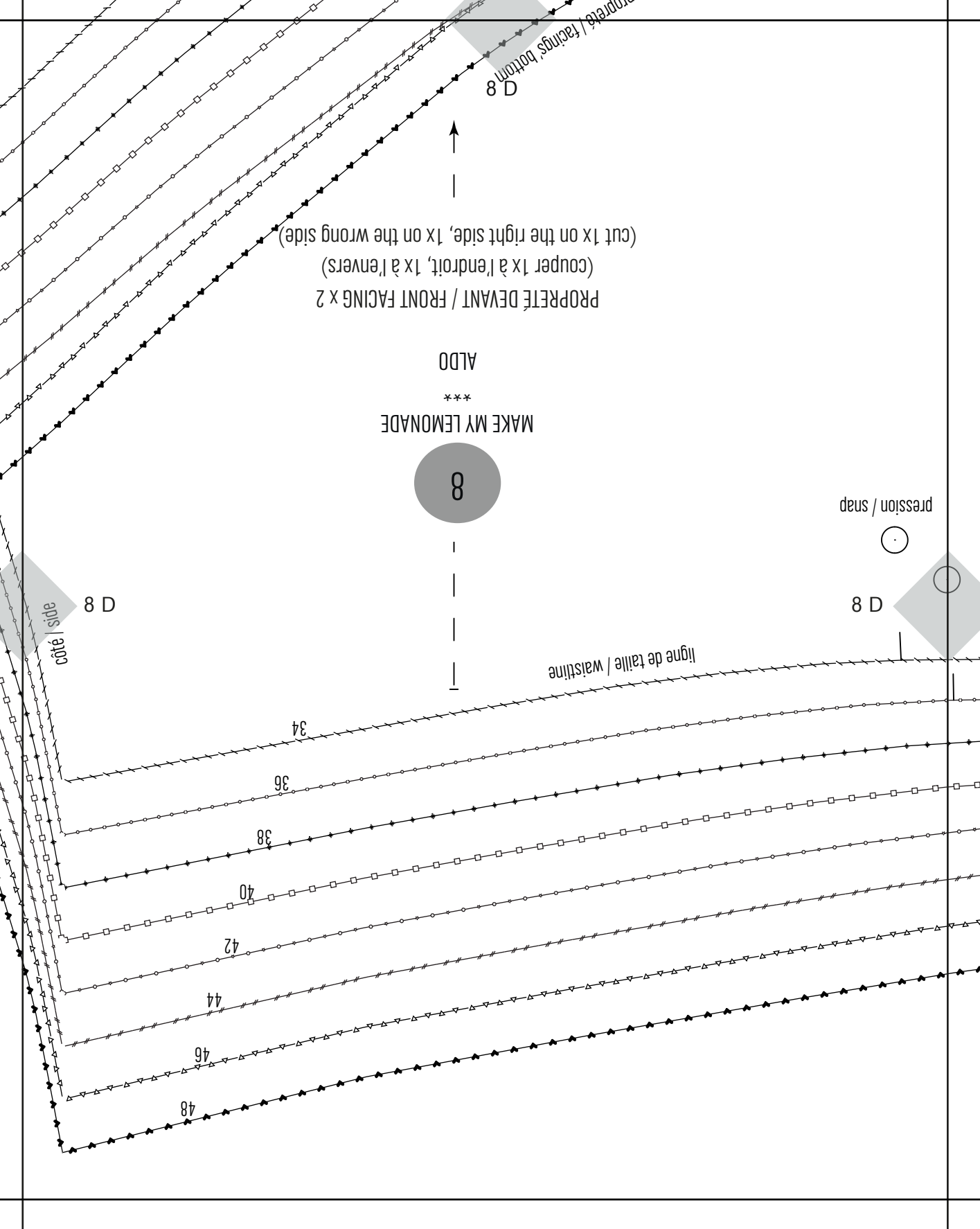

8

MAKE MY LEMONADE

\*\*\*

ALDO

PROPRETÉ DEVANT / FRONT FACING x 2  
 (couper 1x à l'endroit, 1x à l'envers)  
 (cut 1x on the right side, 1x on the wrong side)



pression / snap



8 D

lign de taille / waistline

8 D

côté / side

34

36

38

40

42

44

46

48

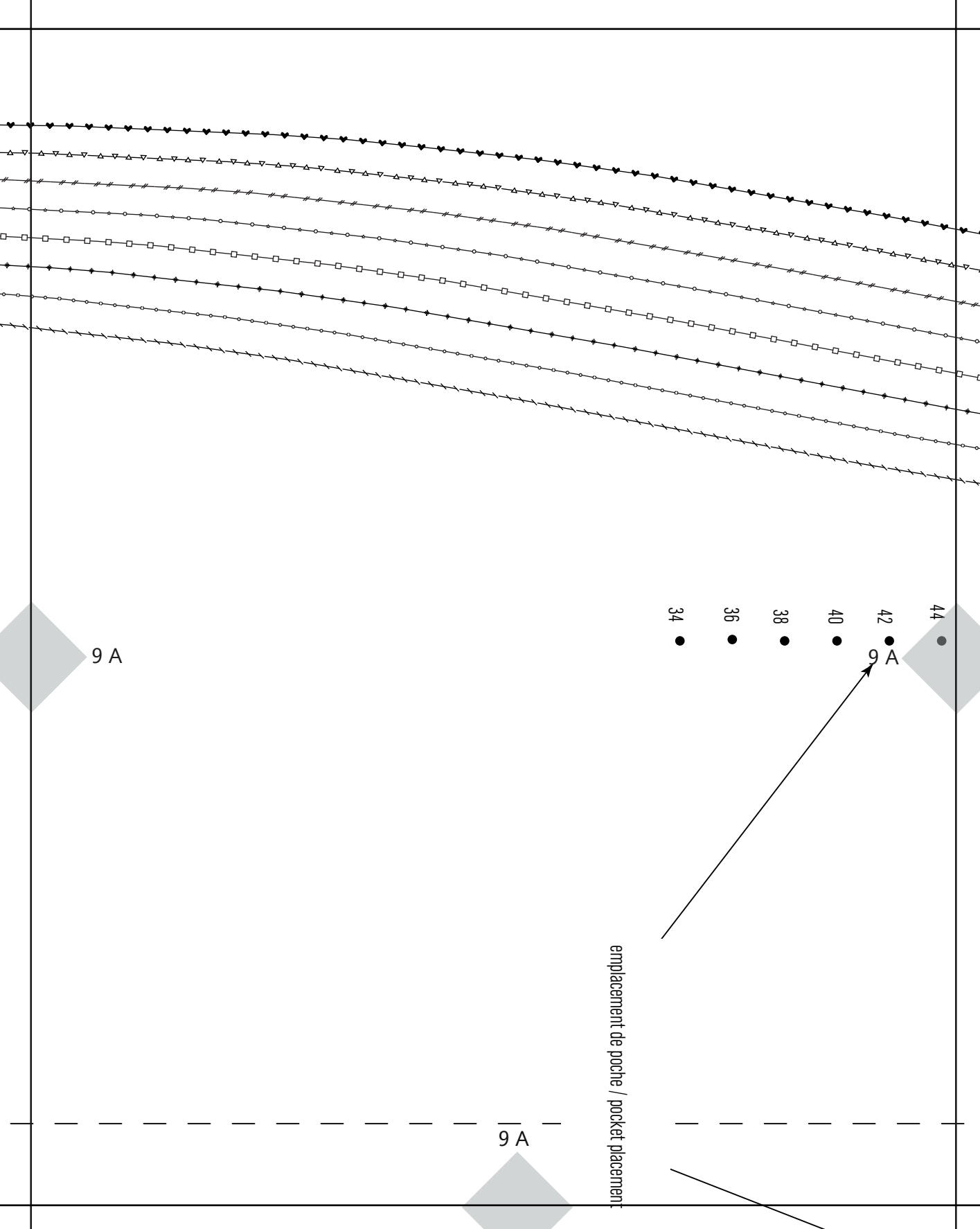

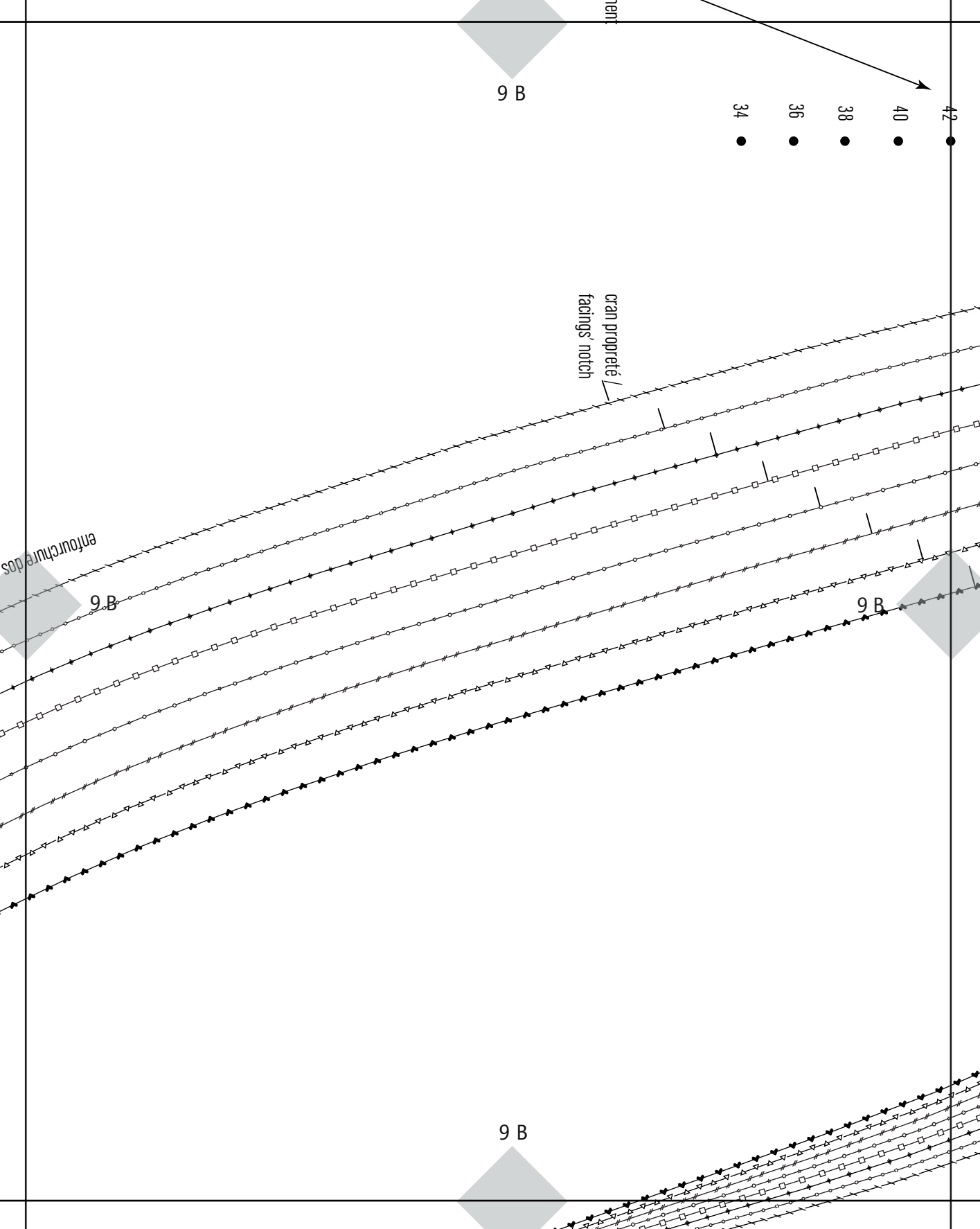

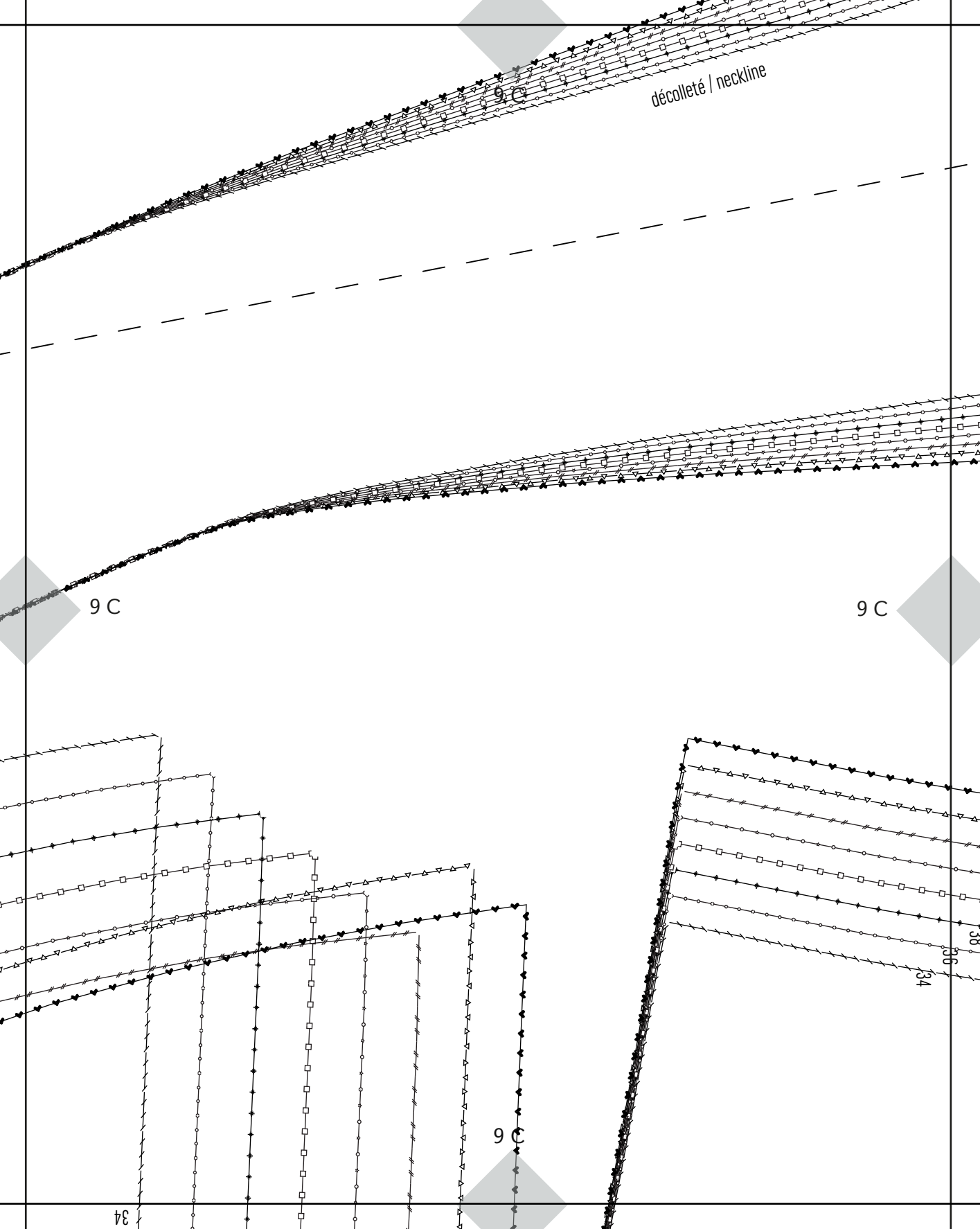

décolleté / neckline

9 C

9 C

9 C

9 C

34

34  
35  
36  
38

PROPRETÉ DOS / BACK FACING x 2

(couper 1x à l'endroit, 1x à l'envers)

(cut 1x on the right side, 1x on the wrong side)

D 6

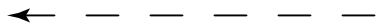

bas de propreté / facings' bottom

D 6  
48

46

44

42

40

38

36

34

milieu devant / middle front

milieu dos / middle back

pre

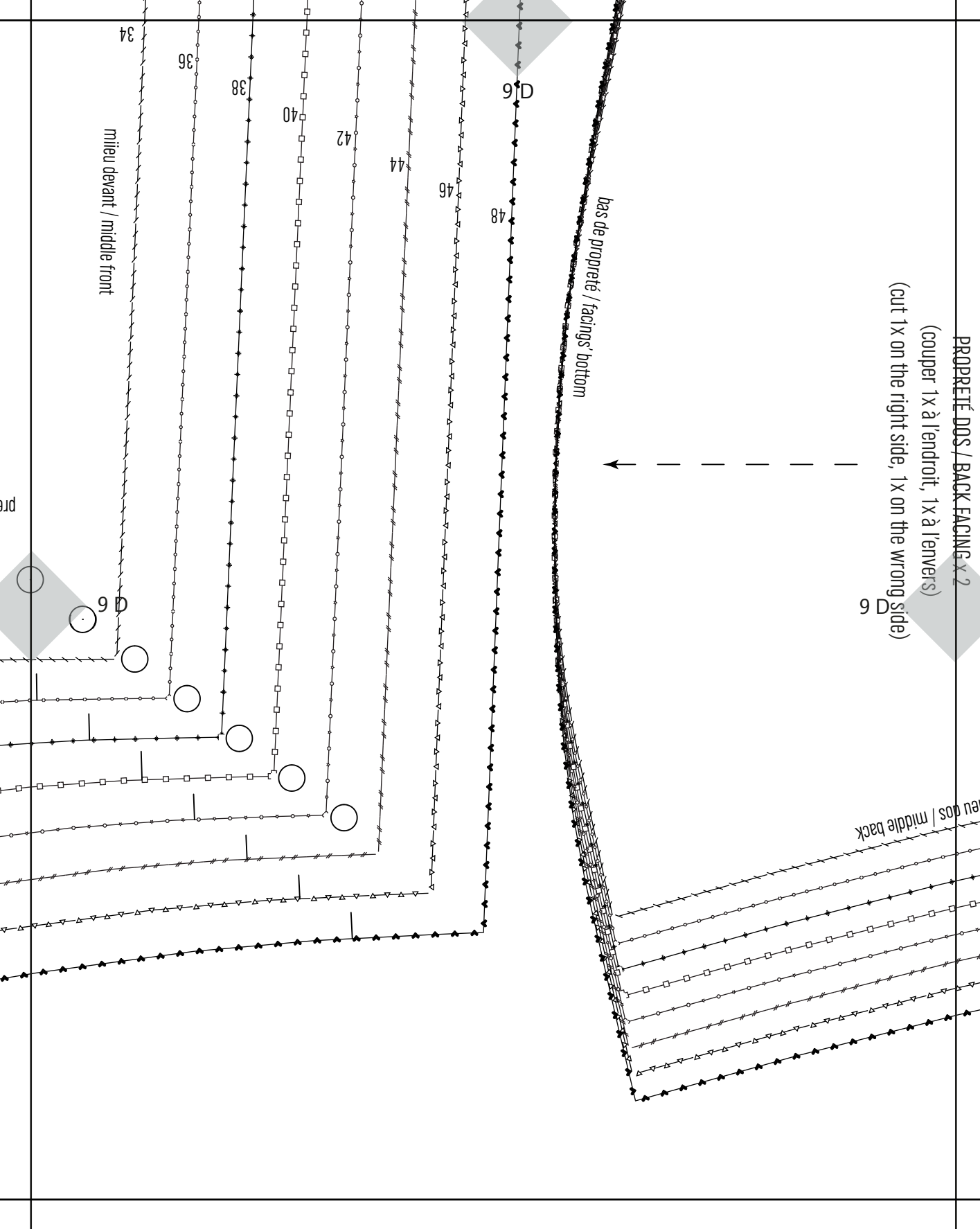

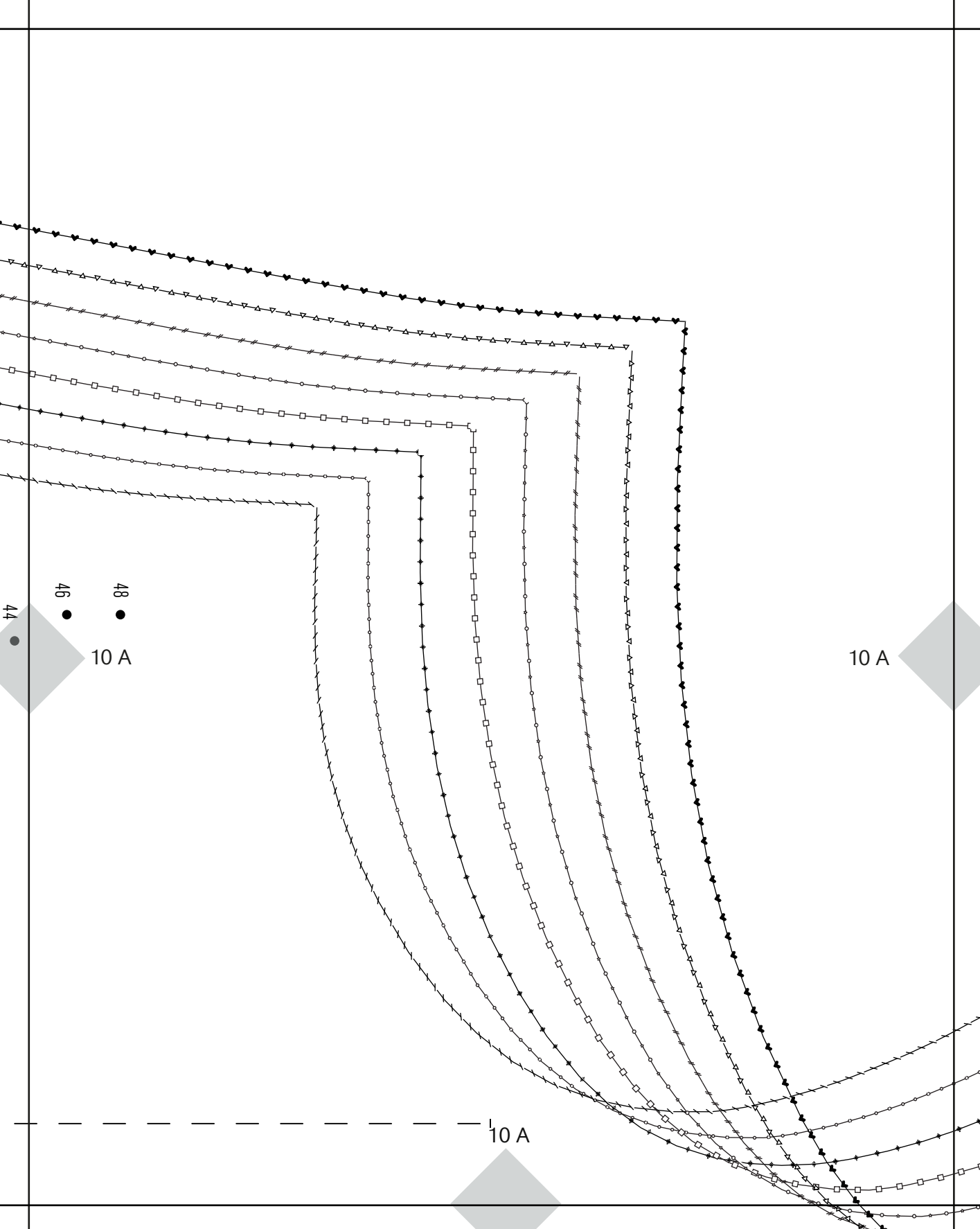

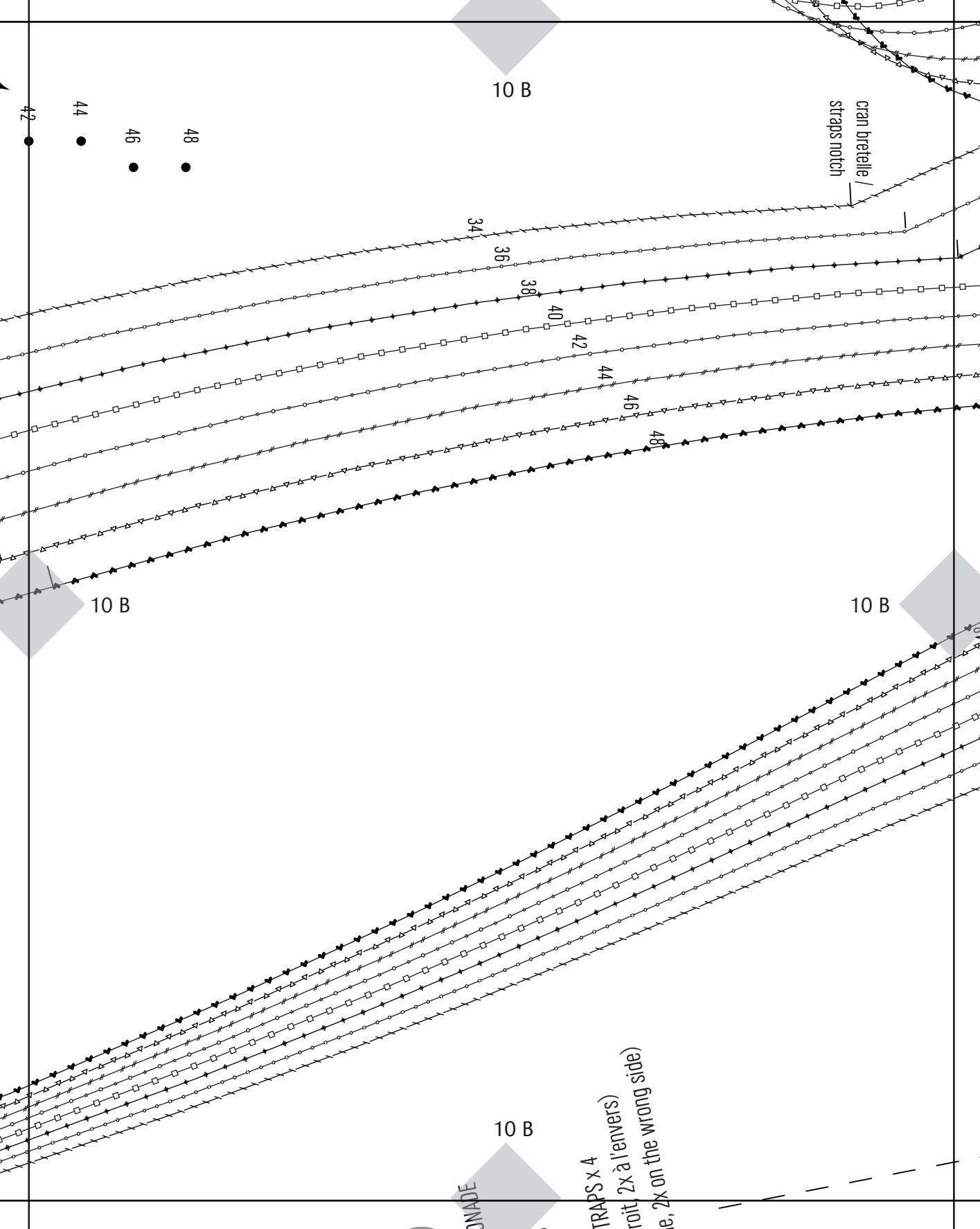

cran bretelle /  
straps notch

10 B

- 42 ●
- 44 ●
- 46 ●
- 48 ●

34

36

38

40

42

44

46

48

10 B

10 B

10 B

TRAPS x 4  
roit 2x à l'envers)  
e, 2x on the wrong side)

UNADE

1

MAKE MY LEMONADE  
9\*\*  
C  
ALDO

BONNET / STRAPS  
couper 2x à l'endroit 2x  
(cut 2x on the right side, 2x on the left side)

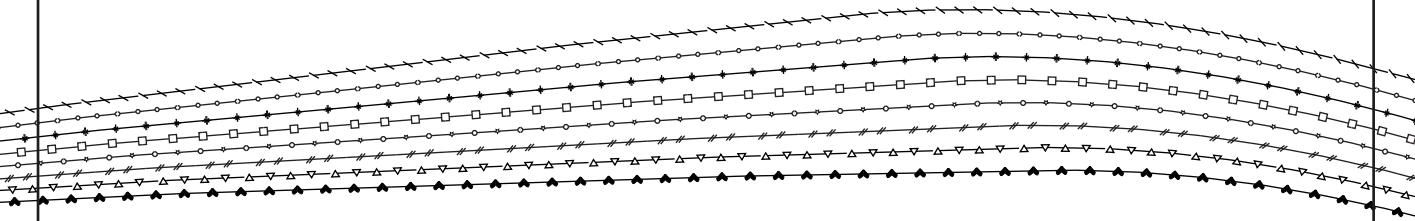

10 C

10 C

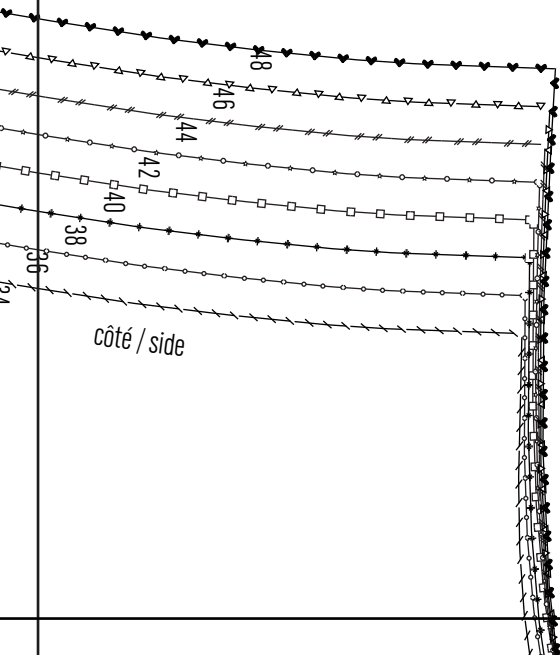

côté / side

10 C

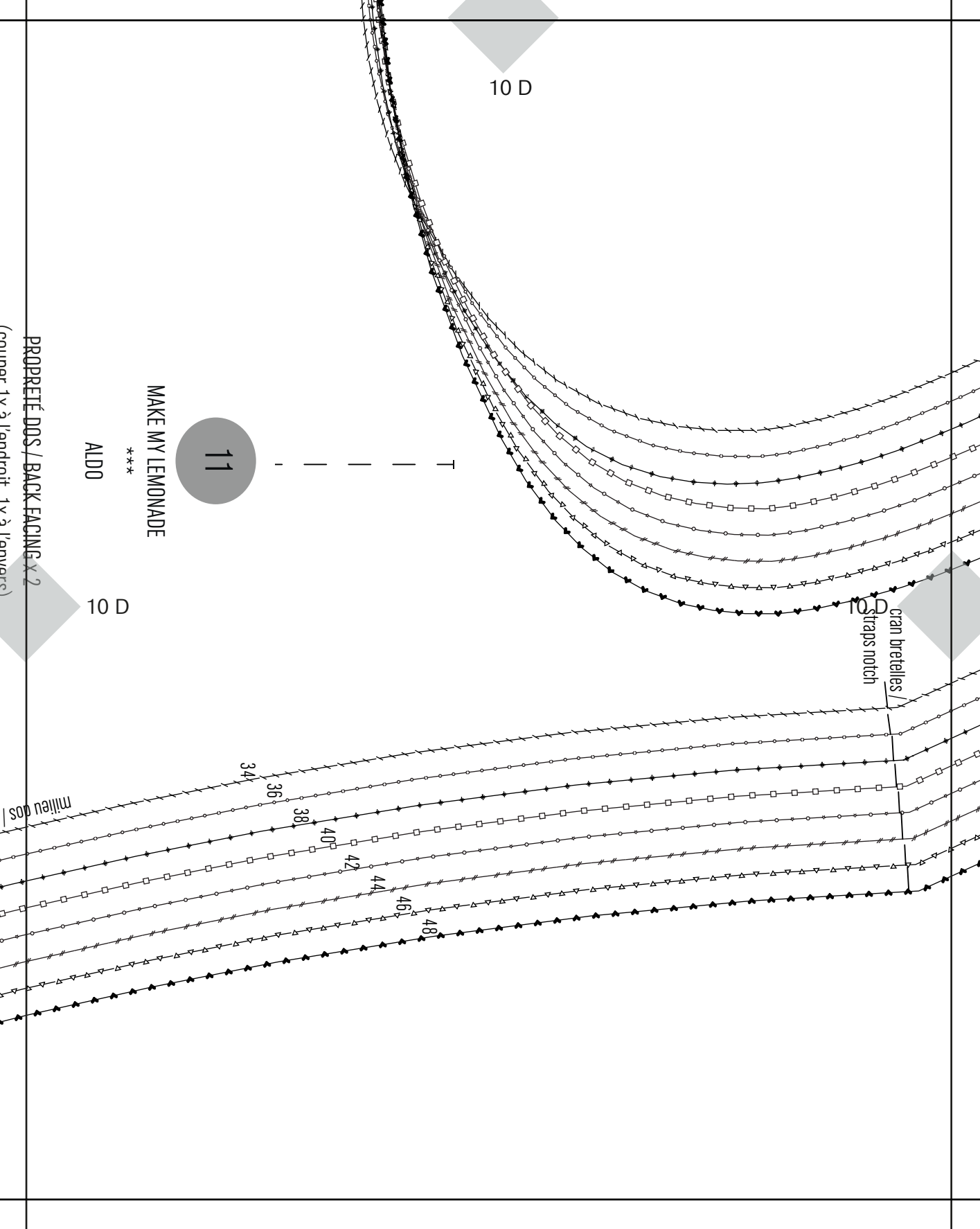

11 A

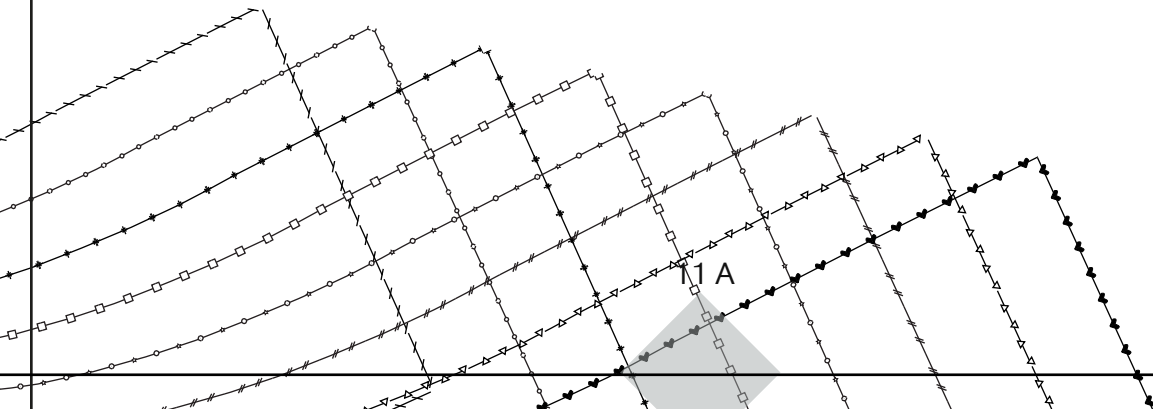

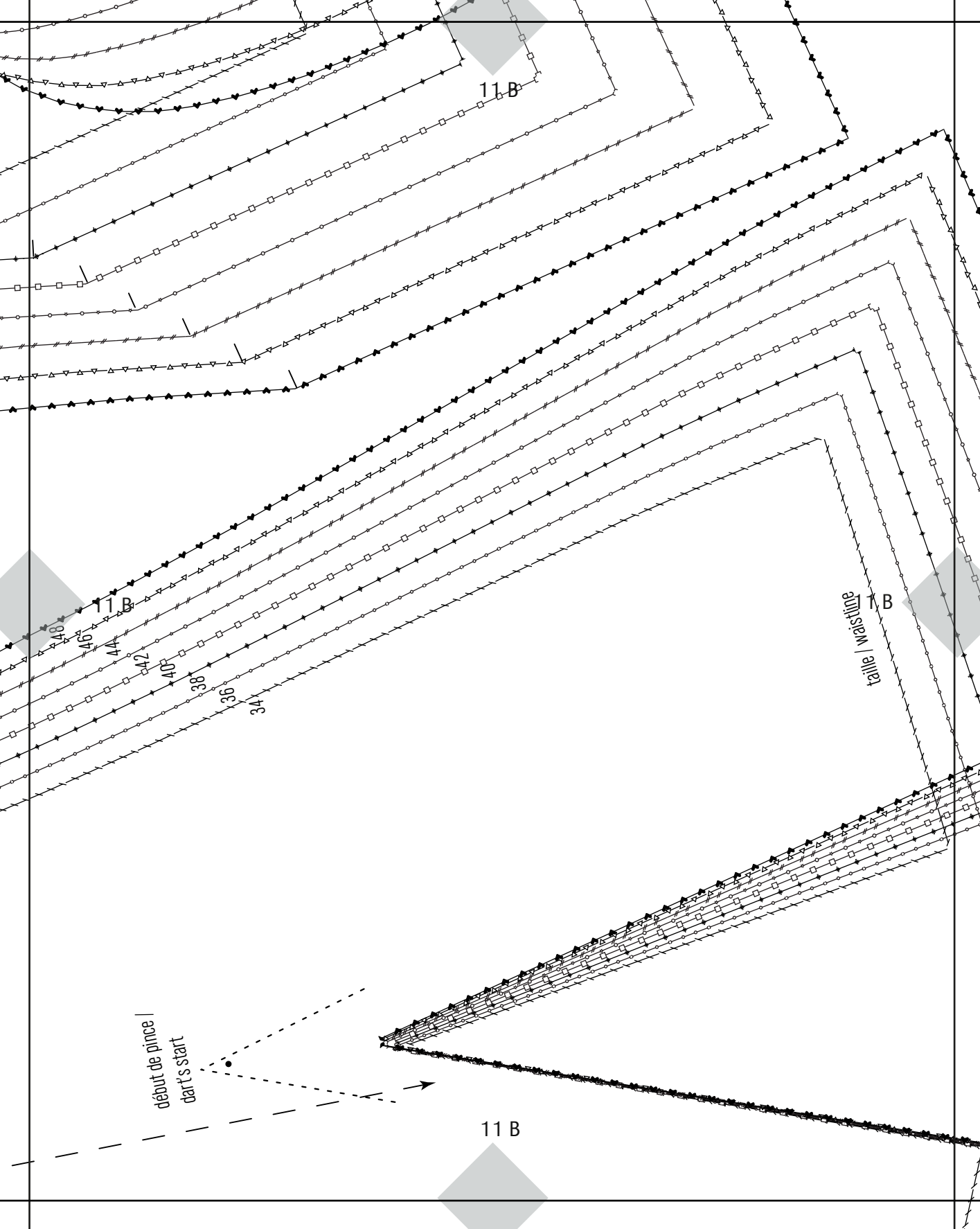

11 C

taille / waistline

34

36

38

40

11 C

11 C

11 C

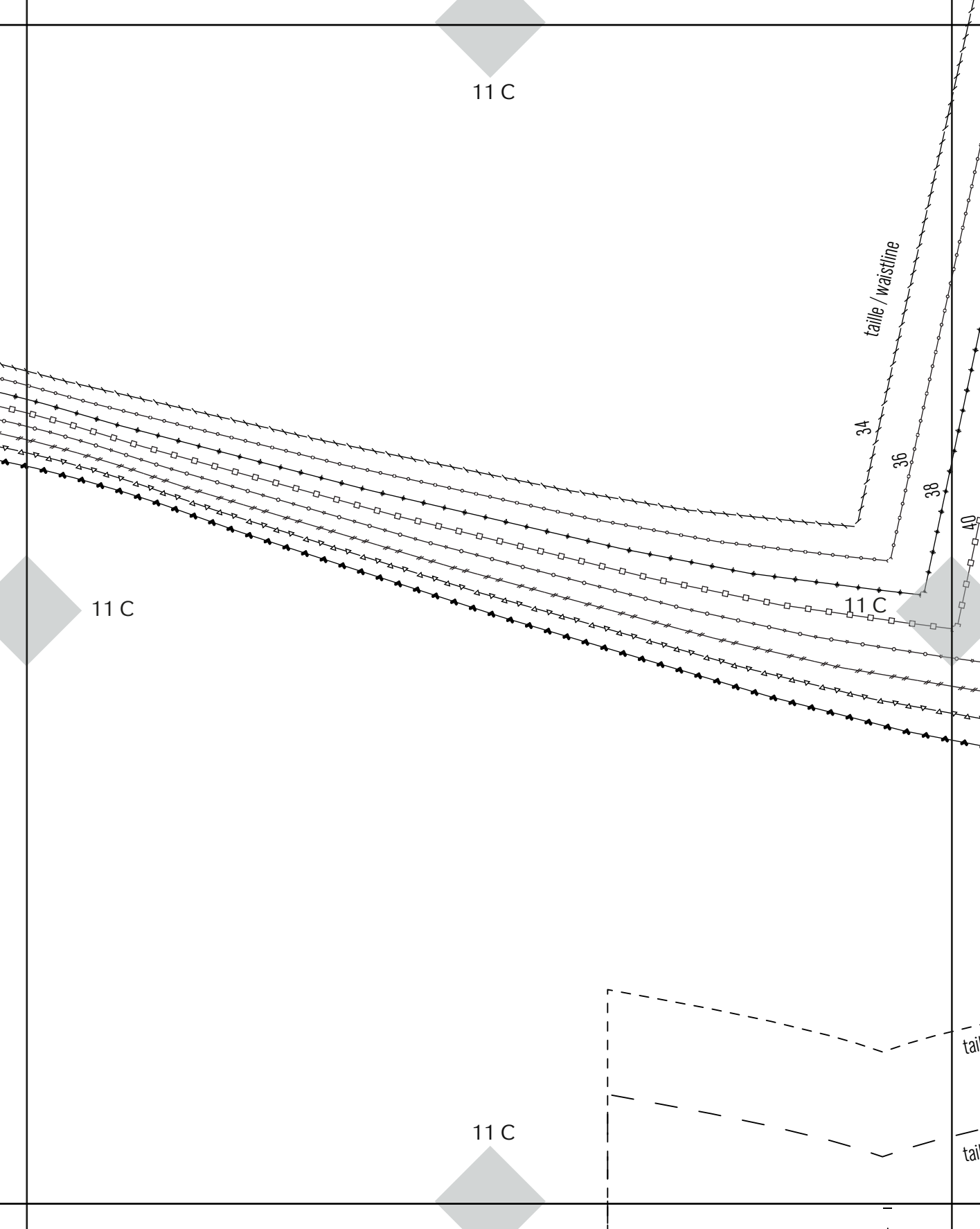

11 D

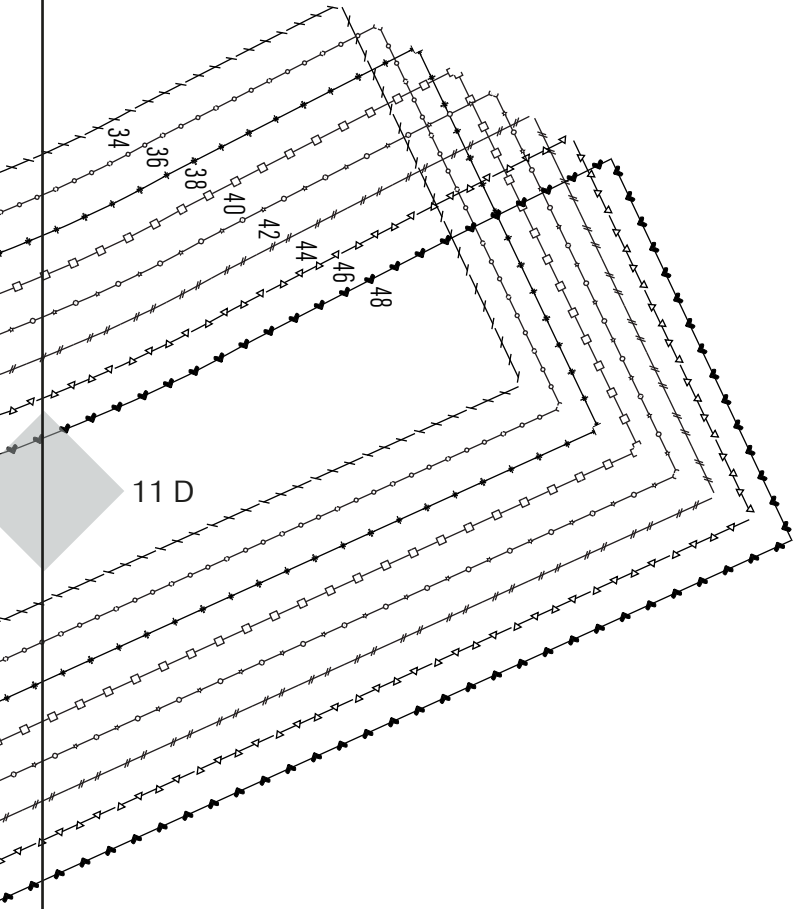

7

MAKE MY LEMONADE

\*\*\*

ALDO

SOUS-PONT / FLY TAB x 1

(couper 1x à l'endroit)

(cut 1x on the right side)

11 D



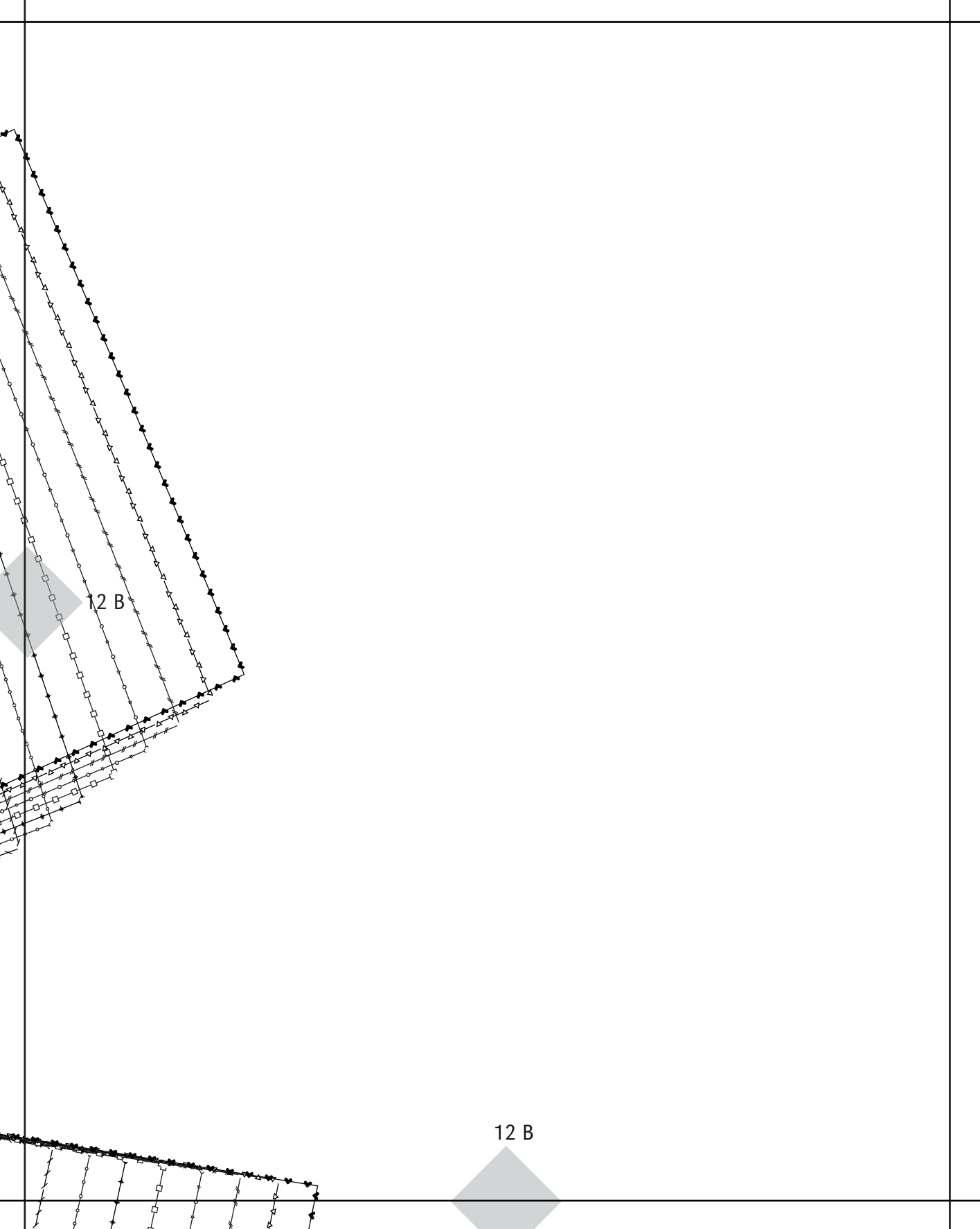

12 B

12 B

12 C

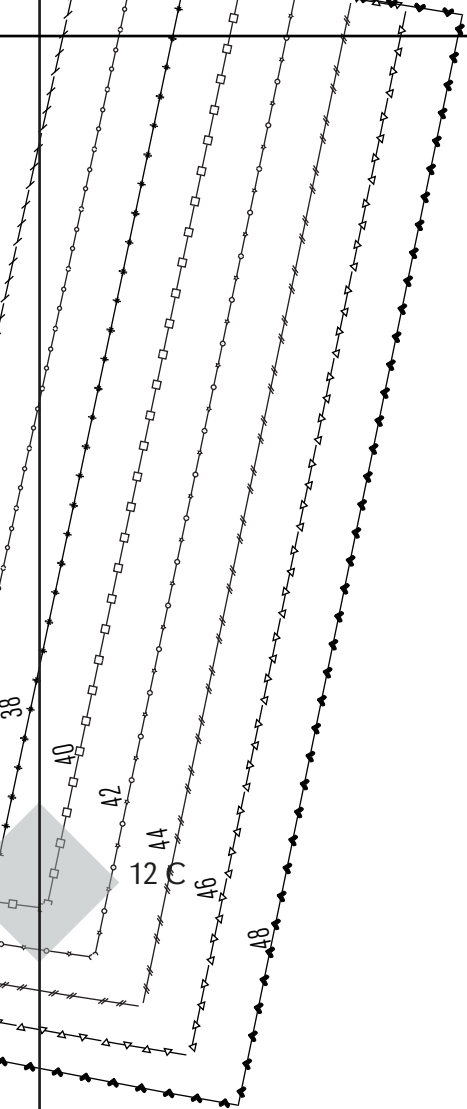

taille 46-48

taille 34-44

12 C

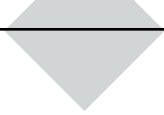

12 D

WADE

TAB x 1  
(droit)  
(right side)

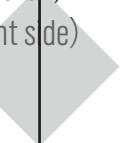

12 D

